

IRWIN®

DRILLING CATALOGUE



Introduction

Since 1885 IRWIN has been manufacturing superior quality tools for trade professionals.

Our exceptional industry knowledge and expertise has enabled us to continually produce better quality products; a tradition of innovation, integrity and service that is making the IRWIN brand synonymous with professional hand tools across the world, is one reason that so many people remain loyal to the IRWIN brand.

Our comprehensive range of quality hand tools and power tool accessories are tried and trusted by trade professionals everywhere. For those who demand high performance and durability, IRWIN guarantees tough, high quality tools that work harder, work better and last longer.

Today, as ever, IRWIN tools are trusted for their superior performance, durability and reliability.

	Page
Drilling Accessories	3
Masonry Drilling	5
Speedhammer Power	6
Speedhammer Plus	9
Speedhammer Max	13
Chisels	14
Masonry	15
Cordless MULTI	18
Granite	20
Diamond	21
Glass and Tile	22
Metal Drilling	23
Turbomax	25
HSS Cobalt	27
HSS Titanium	29
HSS Pro	31
TCT	36
Step Drills	38
Wood Drilling	39
Blue Groove Power	40
Blue Groove 6X	41
Blue Groove 4X	42
Augers	44
Brad Point	45

A Drill Bit for every material

Name of Material	Icon	Masonry	Granite	Cordless MULTI	Speedhammer Plus	Speedhammer Power	Speedhammer Max	Glass&Tile	Diamond	HSS Pro	HSS Cobalt	HSS TIN	Turbomax	Blue Groove 4X/6X	Blue Groove Power	Auger Bits
Rebar Reinforced Concrete					★	★★★★	★★									
Concrete		★★	★★	★	★★★★	★★★★	★★★★									
Limestone		★★★★	★★★★	★★	★★	★★	★★									
Concrete Blocks		★★	★★★★	★	★★★★	★★★★	★★★★									
Aerated Concrete		★★	★★	★★★★	★★	★★	★★									
Brick		★★★★	★★	★★★★	★★	★★	★									
Roof Tile		★★★★	★★	★★★★	★	★	★									
Drywall		★★	★★	★★★★	★	★	★							★	★	★
Marble		★	★	★★★★	★	★	★		★★★★							
Slate		★★	★★	★★★★					★★★★							
Granite		★★	★★★★	★	★★★★	★★★★	★★★★		★★★★							
Eternit		★	★	★★	★	★										
Ceramic Tile		★	★	★★★★	★	★		★★★★	★★★★							
Hard Floor Tile				★★★★					★★★★							
Porcelain				★				★★★★	★★★★							
PVC		★	★	★★★★	★	★				★★★★	★★★★	★★★★	★★★★			
Reinforced Plastic				★★★★						★★★★	★★★★	★★★★	★★★★			
Glass Fiber				★★★★				★	★★	★★★★	★★★★	★★★★	★★★★			
Soft Wood				★						★		★	★	★★★★	★★★★	★★★★
Hard Wood				★						★		★	★	★★★★	★★★★	★★★★
Chipboard				★						★		★	★	★★	★★	★★★★
Nail Embedded Wood															★★★★	
Sheet Metal				★						★★	★★★★	★★★★	★★★★			
Soft Steel				★★						★★	★★	★★★★	★★★★			
High Alloy Steel										★	★★★★	★★	★			
Aluminium & Non-Ferous Metal				★						★	★★★★	★★★★	★★★★			
Stainless Steel											★★★★	★★				

★ = Good ★★ = Better ★★★ = Best

Material Icons: Speedhammer Plus, Speedhammer Power, Speedhammer Max, Granite

 Rebar Concrete	 Masonry	 Granite
---	--	--

Material Icons: Masonry, Cordless Multi, Glass & Tiles, Diamond

 Brick	 Concrete	 Hardest ceramic tiles (scratch hardness 9)	 Marble	 Granite	 Glass	 Ceramic Tiles
--	---	---	---	---	--	--

Material Icons: Metal Drilling

 Steel	 Aluminium & non Ferous	 Stainless Steel	 Cast Iron	 PVC
---	--	---	---	--

Material Icons: Wood Drilling

 Wood	 Nail Embedded Wood
---	---

Feature and Benefits Icons

 Multipurpose usage	 High drilling speed	 Saves battery life	 50x longer life versus standard flat bits	 20% longer life versus standard masonry	 Hex Shank	 Creates perfect and straight holes
 2x more carbide versus standard Speedhammer bit	 Universal 118° point shape	 135° split point shape	 Turbomax point shape	 Single Spur Tip	 6 times faster versus basic flat bits	 4 times faster versus basic flat bits

Safety and Usage Icons

 Safety gloves must be worn	 Eye protection must be worn	 No hammer action	 Water Cooling Requested
---	--	---	--

Masonry Drilling



Speedhammer Power™ Longest lasting Irwin Hammer Drill Bit ever

With 125 years of experience in drill bit manufacturing, product innovation, design, and development, and a full range of products available, IRWIN is serious about drilling.

The new range of Speedhammer POWER™ drill bits is the most powerful yet. The unique tip design with 2X more carbide* is optimized for fast, continuous drilling, even through reinforced concrete, delivering superior performance and 2X longer life*. The Speedhammer POWER™ bit has a high performance tip that's manufactured with 2X more carbide*.

It easily powers through 2X more concrete and rebar than traditional masonry bits. When long life and durability are crucial, depend on the IRWIN Speedhammer POWER™ Bit.

SPEEDHAMMER POWER FEATURES

1. 2X more carbide in tip for longer drilling life even in rebar-reinforced concrete.
2. Maximized Flute for faster, more efficient dust removal and extended life.
3. Optimal Groove Design minimizes friction for increased speed and longer life.
4. Premium Steel (from 5 to 7mm 34CrNiMo6 Steel and from 8 to 20mm 50CrV4 Steel) provides improved core strength for maximum durability and extended life.
5. Blue Power Ring for easier identification in the toolbox.

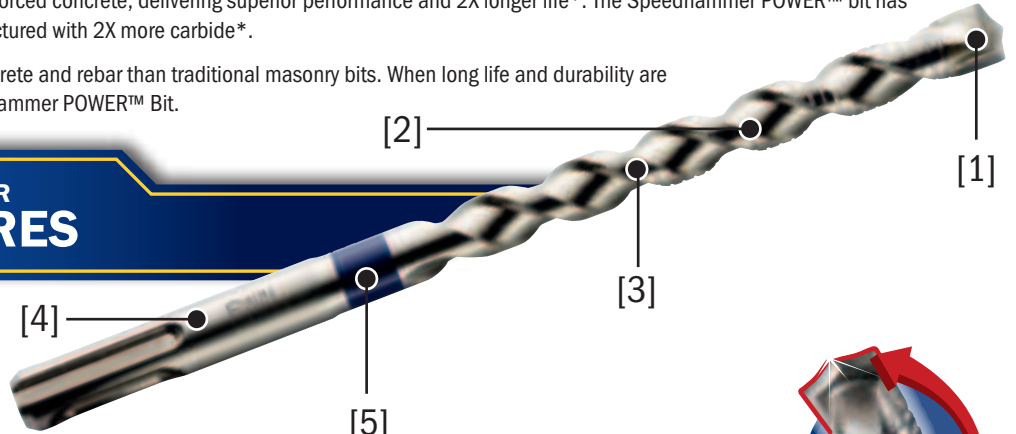

*vs Speedhammer Plus

Life Test

Drill Bits	SDS
Diameter	10x160mm
Drill Bit Qty	3pcs
Material	C40 Concrete
Machine	Hilti TE 6C
Hole Depth	60mm
Test Parameter	Vertical Test

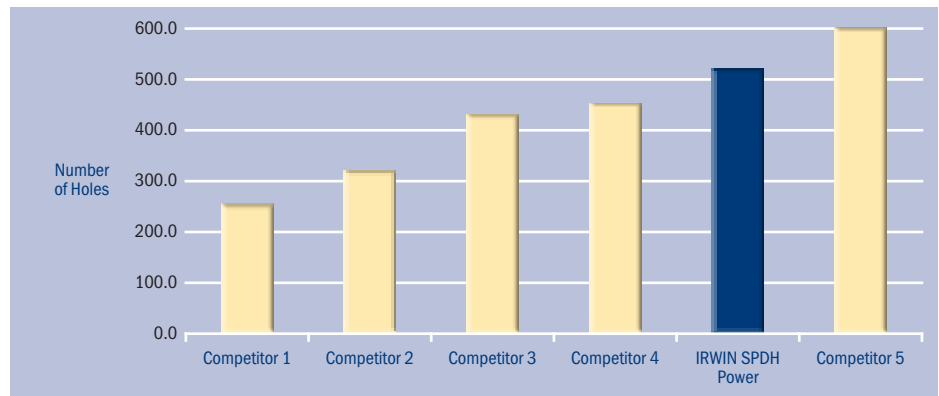

Rebar Durability Test (100% Rebar Hits)

Drill Bits	SDS
Diameter	10x160mm
Drill Bit Qty	3pcs
Material	C25 Concrete with 8mm rebar
Machine	Hilti TE 6C
Hole Depth	60mm
Test Parameter	Vertical Test

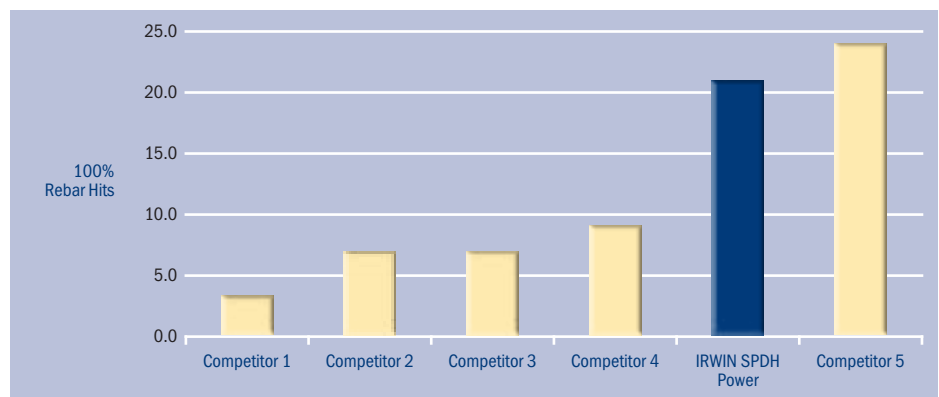

Source: Irwin Tools Test Center

SPEEDHAMMER Power™ Drill Bits

Item No.	Diameter mm	Working Length mm	Total Length mm	EAN	Master Pack	Shelf Pack
10507124	5,0	50	110	5706915071245	200	10
10507125	5,0	100	160	5706915071252	200	10
10507126	6,0	50	110	5706915071269	200	10
10507127	6,0	100	160	5706915071276	200	10
10507128	6,0	150	210	5706915071283	200	10
10507129	6,0	200	260	5706915071290	200	10
10507131	6,5	100	160	5706915071313	200	10
10507132	6,5	150	210	5706915071320	100	10
10507133	6,5	200	260	5706915071337	100	10
10507134	7,0	110	160	5706915071344	200	10
10507135	7,0	150	210	5706915071351	100	10
10507136	8,0	50	110	5706915071368	200	10
10507137	8,0	100	160	5706915071375	200	10
10507138	8,0	150	210	5706915071382	100	10
10507139	8,0	200	260	5706915071399	100	10
10507140	8,0	240	300	5706915071405	100	10
10507142	10,0	50	110	5706915071429	200	10
10507143	10,0	100	160	5706915071436	200	10
10507144	10,0	150	210	5706915071443	100	10
10507145	10,0	200	260	5706915071450	100	10
10507146	10,0	240	300	5706915071467	100	10
10507147	10,0	400	460	5706915071474	100	1
10507148	12,0	100	160	5706915071481	100	10
10507149	12,0	150	210	5706915071498	100	10
10507150	12,0	200	260	5706915071504	100	10
10507151	12,0	240	300	5706915071511	50	10
10507152	12,0	400	460	5706915071528	50	1
10507153	14,0	100	160	5706915071535	100	10
10507154	14,0	150	210	5706915071542	50	10
10507156	14,0	240	300	5706915071566	50	10
10507157	14,0	400	460	5706915071573	20	1
10507159	16,0	150	210	5706915071597	50	1
10507160	16,0	240	300	5706915071603	40	1
10507161	16,0	400	460	5706915071610	20	1
10507163	18,0	240	300	5706915071634	40	1
10507164	18,0	400	460	5706915071641	20	1
10507166	20,0	240	300	5706915071665	40	1
10507167	20,0	400	460	5706915071672	20	1

**SPEED
POWER
HAMMER™**

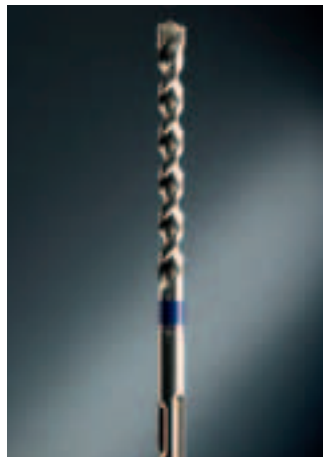
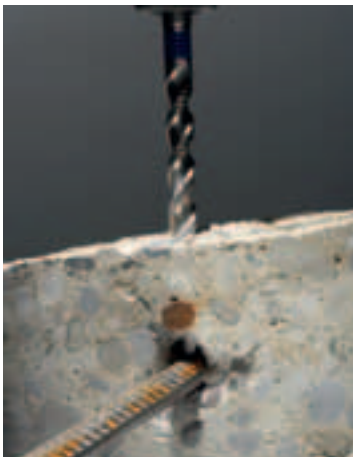

SPEEDHAMMER Power™ Drill Bits 5 Piece Bulk Pack

Item No.	Diameter mm	Working Length mm	Total Length mm	EAN	Master Pack	Shelf Pack
10507168	6,0	50	110	5706915071689	60	1
10507169	6,0	100	160	5706915071696	60	1
10507170	6,0	150	210	5706915071702	40	1
10507171	6,0	200	260	5706915071719	40	1
10507819	6,5	150	210	5706915078190	40	1
10507172	8,0	50	110	5706915071726	40	1
10507173	8,0	100	160	5706915071733	60	1
10507174	8,0	150	210	5706915071740	40	1
10507175	8,0	200	260	5706915071757	40	1
10507176	10,0	50	110	5706915071764	40	1
10507177	10,0	100	160	5706915071771	40	1
10507178	10,0	150	210	5706915071788	30	1
10507179	10,0	200	260	5706915071795	20	1
10507180	12,0	100	160	5706915071801	40	1
10507181	12,0	150	210	5706915071818	30	1
10507182	12,0	200	260	5706915071825	20	1



SPEEDHAMMER Power™ Drill Sets

Item No.	Description	EAN	Master Pack	Shelf Pack
10507183	SPDH Power 5pcs Set: 6/8 x 110, 6/8/10 x 160mm	5706915071832	25	1
10507537	SPDH Power 5pcs Set: 5/6 x 110, 7/8/10 x 160mm	5706915075373	25	1
10507538	SPDH Power 9pcs Set: 1pc - 8 x 110, 10/12 x 160; 2pcs - 6 x 110, 6/8 x 160mm	5706915075380	6	1



Speedhammer Plus™ Fastest Irwin Hammer Drill Bit Ever

SPEEDHAMMER PLUS FEATURES

1. Irwin carbide tip controlled self centering when starting holes; aggressive geometry for faster drilling.
2. Short drill head forces drilling dust into flute.
3. Unique flute design for rapid dust removal, reduces clogging and increases penetration speed.
4. 140° cutting tip provides more cutting surface than competitor's tip, reduces breakout in through-hole applications; centering point prevents walking.
5. Designed for drilling in brick, block, masonry, concrete and granite.

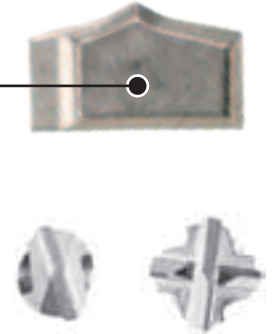
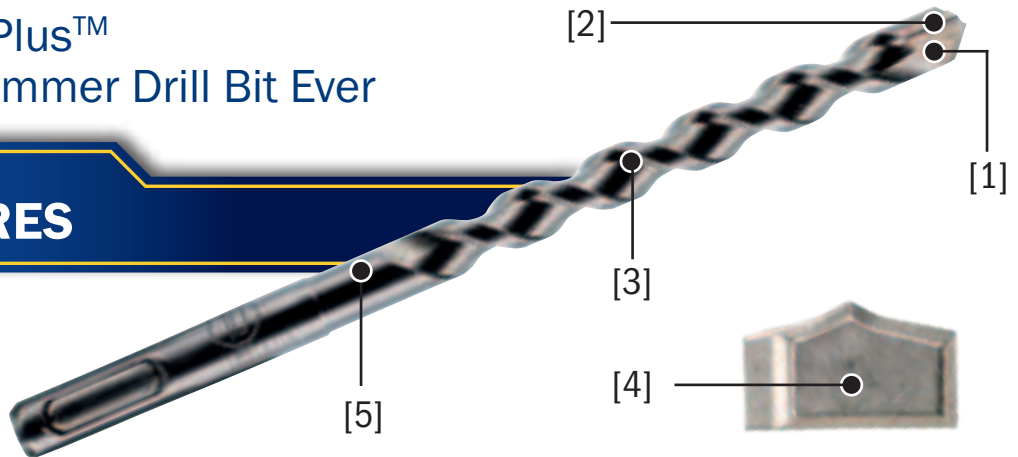

2-cutter Head 4-cutter Head

Speed Test

Drill Bits	SDS
Diameter	8x160mm
Drill Bit Qty	5pcs
Material	C40 Concrete
Machine	Hilti TE 6C
Hole Depth	60mm
Test Parameter	Vertical Test

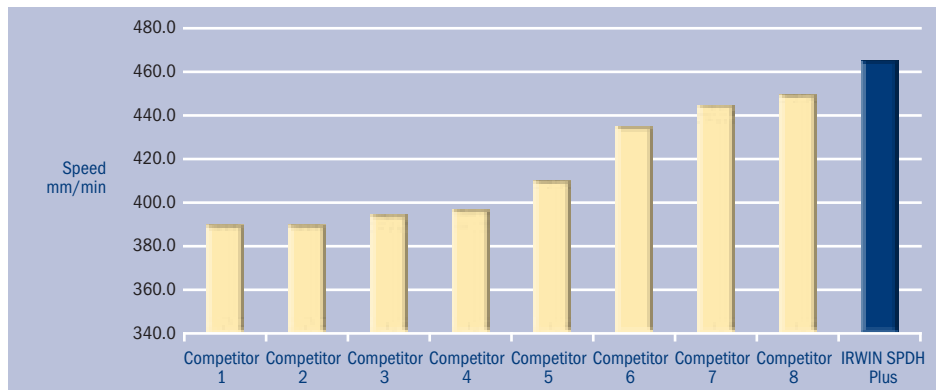

Source: Irwin Tools Test Center

SPEEDHAMMER Plus™ Drill Bits

Item No.	Diameter mm	Working Length mm	Total Length mm	EAN	Master Pack	Shelf Pack
10501941	3,0	50	110	5709131203599	200	10
10507574	3,0	80	140	5706915075748	200	10
10501942	3,5	50	110	5709131061656	200	10
10507575	3,5	80	140	5706915075755	100	10
10501943	4,0	50	110	5709131019282	200	10
10501944	4,0	100	160	5709131019350	200	10
10503844	4,5	100	160	0734442175582	200	1
10501945	5,0	50	110	5709131019466	200	10
10501946	5,0	100	160	5709131019800	200	10
10501947	5,0	150	210	5709131236962	100	10
10501948	5,0	200	260	5709131204237	100	10
10501949	5,5	50	110	5709131020011	200	10
10501950	5,5	100	160	5709131020233	200	10
10501951	5,5	150	210	5709131020363	100	10
10501952	5,5	200	260	5709131281030	100	10
10501953	5,5	240	300	5709131236986	100	10
10501954	6,0	50	110	5709131020400	200	10
10501955	6,0	100	160	5709131020769	200	10
10501956	6,0	150	210	5709131021070	100	10

**SPEED
PLUS
HAMMER™**



SPEEDHAMMER Plus™ Drill Bits

Item No.	Diameter mm	Working Length mm	Total Length mm	EAN	Master Pack	Shelf Pack
IRW10501957	6,0	200	260	5709131021124	100	10
10501958	6,0	240	300	5709131236948	100	10
10501959	6,0	400	460	5709131021162	50	1
10501960	6,5	50	110	5709131021186	200	10
10501961	6,5	100	160	5709131021353	200	10
10501962	6,5	150	210	5709131021537	100	10
10501963	6,5	200	260	5709131021544	100	10
10501964	7,0	50	110	5709131021582	200	10
10501965	7,0	100	160	5709131021704	200	10
10501966	7,0	150	210	5709131021919	100	10
10501967	7,0	340	400	5709131228929	50	10
10501968	8,0	50	110	5709131021971	200	10
10501969	8,0	100	160	5709131022305	200	10
10501970	8,0	150	210	5709131022701	100	10
10501971	8,0	200	260	5709131022947	100	10
10501972	8,0	240	300	5709131023029	100	10
10501973	8,0	400	460	5709131023142	50	1
10501974	8,0	540	600	5709131023227	50	1
10501975	9,0	100	160	5709131023364	200	10
10501976	9,0	150	210	5709131023449	100	10
10501977	9,5	100	160	5709131143093	200	1
10501978	10,0	50	110	5709131023524	200	10
10501979	10,0	100	160	5709131023722	200	10
10501980	10,0	150	210	5709131024095	100	10
10501981	10,0	200	260	5709131024378	100	10
10501982	10,0	240	300	5709131024484	100	10
10501984	10,0	400	460	5709131024620	50	1
10501985	10,0	540	600	5709131024750	50	1
10501986	10,0	940	1000	5709131135418	20	1
10501987	11,0	100	160	5709131024866	100	10
10501988	11,0	200	260	5709131025047	50	10
10501989	11,0	240	300	5709131025061	50	10
10501991	12,0	100	160	5709131025153	100	10
10501992	12,0	150	210	5709131025498	100	10
10501993	12,0	170	230	5709131025610	100	10
10501994	12,0	200	260	5709131025689	100	10
10501995	12,0	240	300	5709131025771	50	10
10501996	12,0	400	460	5709131025917	50	1
10501997	12,0	540	600	5709131026044	20	1
10501998	12,0	740	800	5709131026105	20	1
10501999	12,0	940	1000	5709131026112	20	1
10502000	13,0	100	160	5709131026280	100	10
10502002	13,0	240	300	5709131026488	50	10
10502004	14,0	100	160	5709131026624	100	1
10502005	14,0	150	210	5709131026778	50	1
10502006	14,0	170	230	5709131026846	50	1
10502007	14,0	200	260	5709131026907	50	1
10502008	14,0	240	300	5709131026983	50	1
10502010	14,0	400	460	5709131027058	20	1
10502011	14,0	540	600	5709131027188	20	1
10502012	14,0	940	1000	5709131137610	20	1
10502013	15,0	100	160	5709131027331	100	1
10502014	15,0	170	230	5709131027492	50	1
10502015	15,0	200	260	5709131027539	50	1
10502016	15,0	240	300	5709131027584	40	1
10502017	16,0	100	160	5709131027713	100	1
10502018	16,0	150	210	5709131027829	50	1
10502019	16,0	170	230	5709131027959	50	1
10502020	16,0	240	300	5709131028055	40	1
10502021	16,0	400	460	5709131028154	20	1
10502022	16,0	540	600	5709131028314	20	1
10502023	16,0	740	800	5709131028383	20	1

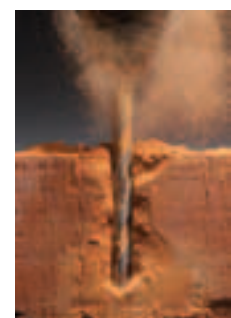

SPEEDHAMMER Plus™ Drill Bits

Item No.	Diameter mm	Working Length mm	Total Length mm	EAN	Master Pack	Shelf Pack
10502024	16,0	940	1000	5709131028413	10	1
10502025	17,0	150	210	5709131028475	50	1
10502027	18,0	150	210	5709131028635	50	1
10502028	18,0	240	300	5709131028857	40	1
10502029	18,0	400	460	5709131028925	20	1
10502030	18,0	540	600	5709131029038	20	1
10502031	18,0	940	1000	5709131096290	10	1
10502033	19,0	240	300	5709131029205	40	1
10502035	19,0	400	460	5709131029267	20	1
10502036	20,0	150	210	5709131029373	50	1
10502038	20,0	240	300	5709131029595	40	1
10502040	20,0	400	460	5709131029670	20	1
10502041	20,0	540	600	5709131029823	10	1
10502042	20,0	940	1000	5709131097129	10	1
10502043	22,0	200	260	5709131029939	25	1
10502044	22,0	240	300	5709131030003	40	1
10502046	22,0	400	460	5709131030126	10	1
10502047	22,0	540	600	5709131030263	10	1
10502048	22,0	940	1000	5709131097594	10	1
10502049	24,0	200	260	5709131030331	10	1
10502050	24,0	240	300	5709131030386	20	1
10502052	24,0	400	460	5709131030478	10	1
10502053	25,0	200	260	5709131030584	10	1
10502054	25,0	240	300	5709131030638	20	1
10502056	25,0	400	460	5709131030720	10	1
10502059	26,0	240	300	5709131030898	20	1
10502057	25,0	550	600	5709131258483	5	1
10502060	26,0	400	460	5709131030942	10	1
10502061	26,0	540	600	5709131128397	10	1

**SPEED
PLUS
HAMMER™**



SPEEDHAMMER Plus™ Drill Bits - 4 Cutting Edges

Item No.	Diameter mm	Working Length mm	Total Length mm	EAN	Master Pack	Shelf Pack
10502069	28,0	400	460	5709131184553	5	1
10502070	30,0	400	460	5709131184577	3	1



4-cutter Head

SPEEDHAMMER Plus™ Drill Bits 5 Piece Bulk Pack

Item No.	Diameter mm	Working Length mm	Total Length mm	EAN	Master Pack	Shelf Pack
10503603	5,0	50	110	5709131286172	1	1
10503604	5,5	50	110	5709131286295	1	1
10503605	6,0	50	110	5709131286202	1	1
10503606	6,0	100	160	5709131285991	1	1
10503607	6,0	150	210	5709131286028	1	1
10503608	6,5	150	210	5709131286059	1	1
10503609	8,0	50	110	5709131280231	1	1
10503610	8,0	100	160	5709131286110	1	1
10503611	8,0	150	210	5709131286080	1	1
10503612	10,0	100	160	5709131286141	1	1
10503613	10,0	150	210	5709131286325	1	1



SPEEDHAMMER Plus™ Drill Bits 10 Piece Bulk Quadro Pack

Item No.	Diameter mm	Working Length mm	Total Length mm	EAN	Master Pack	Shelf Pack
10502071	5,0	50	110	5709131176206	30	1
10502072	5,0	100	160	5709131176220	30	1
10502073	5,5	50	110	5709131176244	30	1
10502074	5,5	100	160	5709131176268	30	1
10502075	6,0	50	110	5709131176282	1	1
10502076	6,0	100	160	5709131176305	30	1
10502077	6,0	150	210	5709131228943	20	1
10502080	6,5	150	210	5709131230823	20	1
10502082	8,0	100	160	5709131253273	30	1
10503845	7,0	100	160	0734442175827	30	1
10502083	8,0	150	210	5709131176428	20	1
10502084	10,0	50	110	5709131176442	30	1
10502085	10,0	100	160	5709131253341	25	1
10502086	10,0	150	210	5709131176480	25	1
10502087	12,0	100	160	5709131176503	25	1
10502088	12,0	150	210	5709131230199	20	1



SPEEDHAMMER Plus™ Drill Bits 25 Piece Bulk Quadro Pack

Item No.	Diameter mm	Working Length mm	Total Length mm	EAN	Master Pack	Shelf Pack
10503615	5,0	50	110	5706915936148	1	1
10503616	6,0	100	160	5706915936162	1	1
10503617	8,0	100	160	5706915936179	1	1
10503618	10,0	100	160	5706915936186	1	1



SPEEDHAMMER Plus™ Drill Bit Cassettes

Item No.	Description	EAN	Master Pack	Shelf Pack
10502089	SPDH Plus 5pcs Set : 1pc - 5/6 x 110, 8/10/12 x 160mm	5709131268871	25	1
10507110	SPDH Plus 9pcs Set, NE : 1pc - 5/5,5/6 x 110, 5,5/8/10/12 x 160 ; 2pcs - 6 x 160mm	5706915071108	6	1
10507111	SPDH Plus 9pcs Set, SE : 1pc - 5/8 x 110, 8/10/12 x 160 ; 2pcs - 6 x 110, 6 x 160mm	5706915071115	6	1



Speedhammer MAX™ designed for tougher tasks!

SPEEDHAMMER MAX FEATURES

1. Irwin tip design enhances dust removal and provides symmetrical holes.

Head takes 80% of the workload, ensuring higher durability, speed and rebar performance.

53° drilling head design means more aggressive cutting and faster dust removal for overall faster performance.

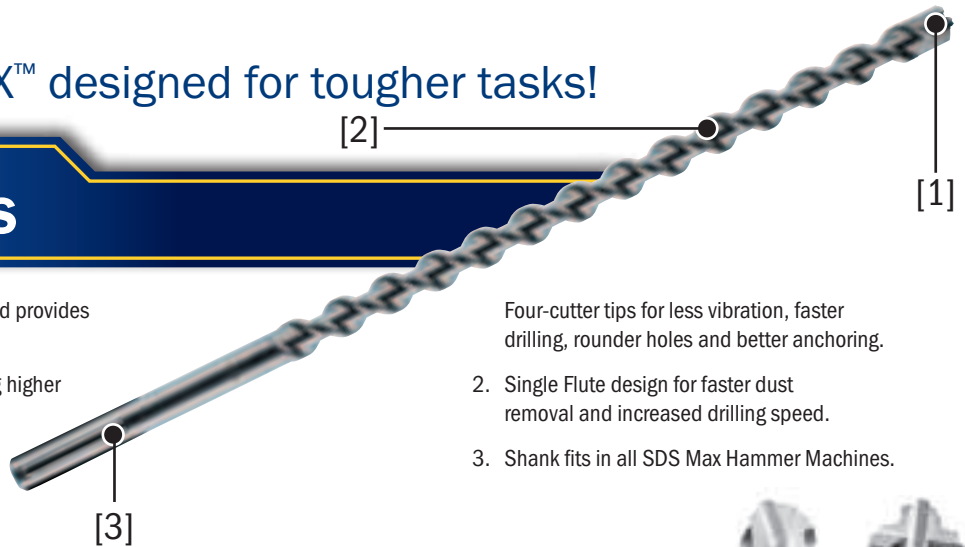

Four-cutter tips for less vibration, faster drilling, rounder holes and better anchoring.

2. Single Flute design for faster dust removal and increased drilling speed.

3. Shank fits in all SDS Max Hammer Machines.



2-cutter Head 4-cutter Head



SPEEDHAMMER Max™ Drill Bits 2 Cutting Edges

Item No.	Diameter mm	Working Length mm	Total Length mm	EAN	Master Pack	Shelf Pack
10502092	12,0	200	340	5709131233756	25	1
10502093	12,0	400	540	5709131233770	10	1
10502094	12,0	550	690	5709131233794	10	1
10502095	14,0	200	340	5709131233817	25	1
10502096	14,0	400	540	5709131233831	10	1
10502097	15,0	200	340	5709131233855	25	1
10502098	15,0	400	540	5709131233879	10	1

SPEEDHAMMER Max™ Drill Bits 4 Cutting Edges

Item No.	Diameter mm	Working Length mm	Total Length mm	EAN	Master Pack	Shelf Pack
10502099	16,0	200	340	5709131233893	25	1
10502100	16,0	400	540	5709131233916	10	1
10502101	18,0	200	340	5709131233930	25	1
10502102	18,0	400	540	5709131233954	10	1
10502103	20,0	200	320	5709131233978	25	1
10502104	20,0	400	520	5709131233992	10	1
10502105	20,0	800	920	5709131234012	5	1
10502106	22,0	200	320	5709131234036	25	1
10502107	22,0	400	520	5709131234050	10	1
10502108	22,0	800	920	5709131234074	5	1
10502109	24,0	200	320	5709131234098	10	1
10502110	24,0	400	520	5709131234111	5	1
10502111	25,0	200	320	5709131234135	10	1
10502112	25,0	400	520	5709131234159	5	1
10502113	25,0	800	920	5709131234173	5	1
10502115	28,0	250	370	5709131234197	5	1
10502116	28,0	450	570	5709131234210	5	1
10502117	28,0	550	670	5709131234234	5	1
10502118	30,0	250	370	5709131234241	3	1
10502119	30,0	450	570	5709131234272	3	1
10502120	32,0	250	370	5709131234296	3	1
10502121	32,0	450	570	5709131234319	3	1
10502122	32,0	800	920	5709131234333	3	1
10502123	35,0	250	370	5709131234340	3	1
10502124	35,0	450	570	5709131234364	3	1
10502125	35,0	550	670	5709131234388	2	1
10502126	38,0	250	370	5709131234395	2	1
10502127	38,0	450	570	5709131234401	2	1
10502128	40,0	250	370	5709131234418	2	1
10502129	40,0	430	570	5709131234425	2	1
10502130	40,0	780	920	5709131234647	2	1



Chisels

**SPEEDHAMMER CHISELS
FEATURES**



For a wide range of applications for both SDS Plus and SDS Max hammer drills: breaking through, breaking up concrete, light demolition work and chasing of channels for pipes and electrical conduit .

Application:
Concrete and masonry
Grey sandblasted professional finish

SPEEDHAMMER Plus™ Demolition Chisels

Item No.	Description	EAN	Master Pack	Shelf Pack
10502194	Pointed Chisel 250mm	5709131281979	-	1
10502195	Flat Chisel 20 x 250mm	5709131281986	-	1
10502196	Spade Chisel 40 x 250mm	5709131281993	-	1
10502197	Gouge Chisel 22 x 250mm	5709131282006	-	1
10502198	TCT Pointing Chisel 32 x 125mm	5709131285595	-	1
10502200	TCT Pointing Chisel 32 x 200mm	5709131285601	-	1
10503643	Cranked Tile Chisel 40 x 250mm	5706915001273	-	1
10502201	Chisels Set 3 pcs. Pointed, Flat & Spade	5709131285571	-	1

SPEEDHAMMER Max™ Demolition Chisels

Item No.	Description	EAN	Master Pack	Shelf Pack
10502184	Pointed Chisel 280mm	5709131281870	-	1
10502185	Pointed Chisel 400mm	5709131281887	-	1
10502186	Pointed Chisel 600mm	5709131281894	-	1
10502187	Flat Chisel 25 x 280mm	5709131281900	-	1
10502188	Flat Chisel 25 x 400mm	5709131281917	-	1
10502189	Flat Chisel 25 x 600mm	5709131281924	-	1
10502190	Spade Chisel 115 x 350mm	5709131281931	-	1
10502191	Spade Chisel 50 x 400mm	5709131281948	-	1
10502192	Spade Chisel 80 x 300mm	5709131281955	-	1
10502193	Gouge Chisel 26 x 300mm	5709131281962	-	1
10502199	TCT Pointing Chisel 38 x 280mm	5709131285588	-	1
10503644	Cranked Tile Chisel 50 x 400mm	5706915001297	-	1



Masonry

Now 20% more life vs previous version.

MASONRY FEATURES



1. Improved carbide tip design ensures for durable and fast drilling in all masonry materials.
 Aggressive head design for 15% Speed advantage over competition.
 Now 20% more life vs. previous version.
2. Single flute design giving maximum space for dust removal and provides a 60% faster dust removal.



20% more life vs previous version



Life and Speed Test

Drill Bits	Masonry Drill Bits
Diameter	6x110mm
Drill Bit Qty	5pcs to 3pcs
Material	C25 Concrete
Machine	DW 165
RPM	2400
Hole Depth	30mm
Test Parameters	Vertical Test
Speed Test Results	New Masonry Drill Bits sustain speed advantage over competitor
Life Test Results	New Masonry Drill Bits is the longest lasting masonry Drill Bit. Up to 20% more life vs. previous version

Life Test after 6 m

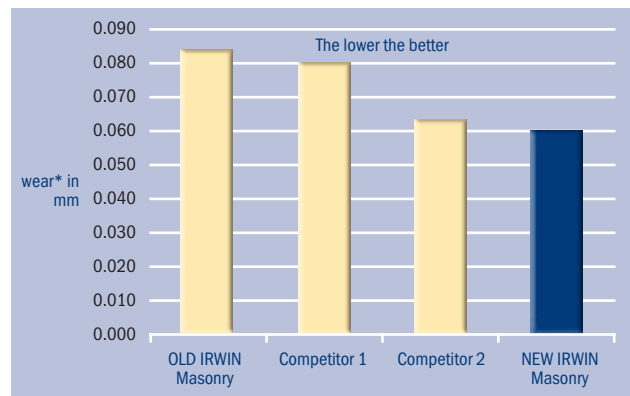

Speed Test in the Beginning

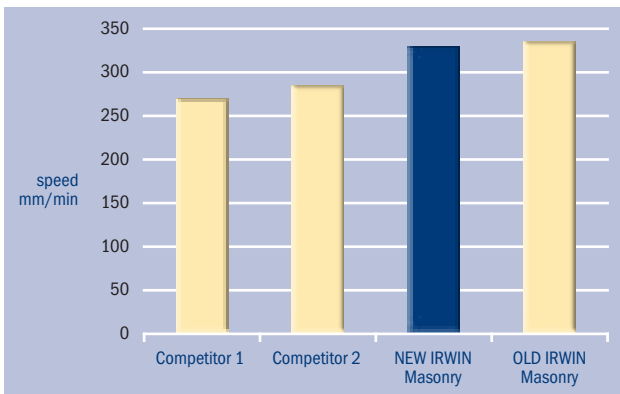

Speed Test after 6 m

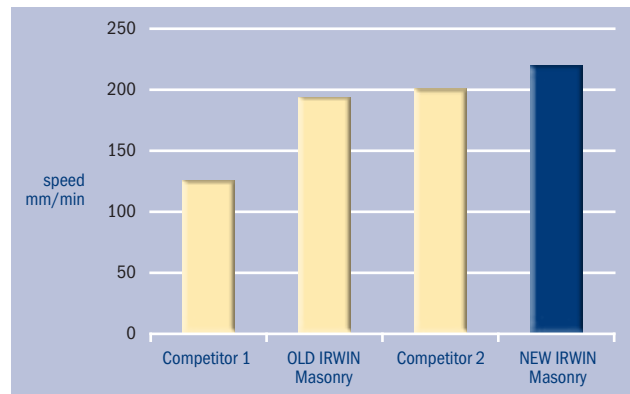

* wear = the wear of the drill bit is measured before and after drilling. The lower the wear the more durable and longer lasting the drill bit is.
 Source: Irwin Tools Test Center

Masonry Drill Bits - Straight Shank Rotary Percussion

Item No.	Diameter mm	Working Length mm	Total Length mm	Shank Diameter mm	EAN	Master Pack	Shelf Pack
10501812	3,0	40	70	CYL as Ø	5709131000129	200	10
10501813	3,5	45	75	CYL as Ø	5709131000211	200	10
10501814	4,0	45	80	CYL as Ø	5709131055839	200	10
10501815	4,0	115	160	CYL as Ø	5709131055075	200	10
10501816	4,5	45	85	CYL as Ø	5709131000488	200	10
10501817	5,0	50	90	CYL as Ø	5709131055846	200	10
10501818	5,0	115	160	CYL as Ø	5709131000778	200	10
10501819	5,5	55	95	CYL as Ø	5709131055853	200	10
10501820	5,5	115	160	CYL as Ø	5709131000952	200	10
10501821	6,0	60	100	CYL as Ø	5709131055860	200	10
10501822	6,0	115	160	CYL as Ø	5709131055877	200	10
10501824	6,0	300	400	CYL as Ø	5709131001249	50	1
10501825	6,0	500	600	CYL as Ø	5709131001287	50	1
10501826	6,5	60	105	CYL as Ø	5709131055884	200	10
10501827	6,5	115	160	CYL as Ø	5709131001461	200	10
10501829	6,5	300	400	CYL as Ø	5709131001546	50	1
10501830	7,0	65	110	CYL as Ø	5709131055891	200	10
10501831	7,0	115	160	CYL as Ø	5709131055907	200	10
10501833	7,5	70	115	CYL as Ø	5709131001805	200	10
10501834	8,0	70	120	CYL as Ø	5709131055914	200	10
10501835	8,0	110	160	CYL as Ø	5709131002055	200	10
10501836	8,0	130	200	CYL as Ø	5709131055921	100	10
10501838	8,0	300	400	CYL as Ø	5709131002147	50	1
10501839	8,0	500	600	CYL as Ø	5709131002215	50	1
10501840	8,5	75	125	CYL as Ø	5709131002307	200	10
10501841	9,0	80	130	CYL as Ø	5709131002352	200	10
10501842	9,5	85	135	CYL as Ø	5709131002482	200	10
10501845	9,5	300	400	CYL as Ø	5709131002673	50	1
10501846	10,0	90	140	CYL as Ø	5709131055938	200	10
10501847	10,0	110	160	CYL as Ø	5709131002871	200	10
10501848	10,0	130	200	CYL as Ø	5709131055945	100	10
10501850	10,0	300	400	CYL as Ø	5709131002987	50	1
10501851	10,0	500	600	CYL as Ø	5709131003007	50	1
10501852	10,0	900	1000	CYL as Ø	5709131003021	50	1
10501853	11,0	105	160	CYL as Ø	5709131003182	50	10
10501854	12,0	105	160	CYL as Ø	5709131055952	50	10
10501856	12,0	300	400	CYL as Ø	5709131003403	30	1
10501857	12,0	500	600	CYL as Ø	5709131003434	30	1
10501858	12,0	900	1000	CYL as Ø	5709131003465	25	1
10501859	13,0	100	160	10	5709131003526	50	10
10501861	13,0	300	400	10	5709131003663	30	1
10501862	14,0	100	160	10	5709131055969	50	10
10501864	14,0	300	400	10	5709131003786	30	1
10501865	14,0	500	600	10	5709131003809	30	1
10501866	15,0	85	160	10	5709131003878	50	1
10501867	16,0	85	160	10	5709131003915	50	1
10501869	16,0	300	400	10	5709131003991	15	1
10501870	16,0	500	600	13	5709131004035	15	1
10501871	16,0	900	1000	13	5709131004059	15	1
10501872	17,0	80	160	13	5709131004097	50	1
10501873	18,0	80	160	13	5709131004158	50	1
10501874	18,0	300	400	13	5709131004172	15	1
10501875	18,0	500	600	13	5709131004196	15	1
10501876	19,0	80	160	13	5709131004257	50	1
10501877	19,0	300	400	13	5709131004295	10	1
10501878	20,0	80	160	13	5709131004325	50	1
10501880	20,0	300	400	13	5709131004356	10	1
10501881	20,0	500	600	13	5709131004370	10	1
10501882	22,0	80	160	13	5709131004424	50	1
10501884	22,0	300	400	13	5709131004486	10	1

MASONRY



Masonry Drill Bits - Straight Shank Rotary Percussion



MASONRY

Item No.	Diameter mm	Working Length mm	Total Length mm	Shank Diameter	EAN	Master Pack	Shelf Pack
10501885	24,0	80	160	13	5709131004530	25	1
10501886	24,0	300	400	13	5709131004554	5	1
10501888	26,0	80	160	13	5709131004608	25	1
10501890	26,0	300	400	13	5709131004646	5	1
10501891	28,0	300	400	13	5709131004691	5	1

Masonry Drill Bit Cassettes

Item No.	Description	EAN	Master Pack	Shelf Pack
10501892	5pcs Set: 4/5/6/8/10mm	5709131248125	60	15
10501893	7pcs Set: 4/5/6/7/8/10/12mm	5709131248149	32	8



**Cordless Multi
One drill bit for every need!**

**CORDLESS MULTI
FEATURES**

1. Hardest carbide grade and unique point grinding for fast drilling into most common materials and hardest tiles (scratch hardness 9).
2. Single flute design giving maximum space for dust removal. Up to 15% Speed advantage over competition. 10% more holes per battery charge.



Low RPM.
High pressure.
No hammer action.

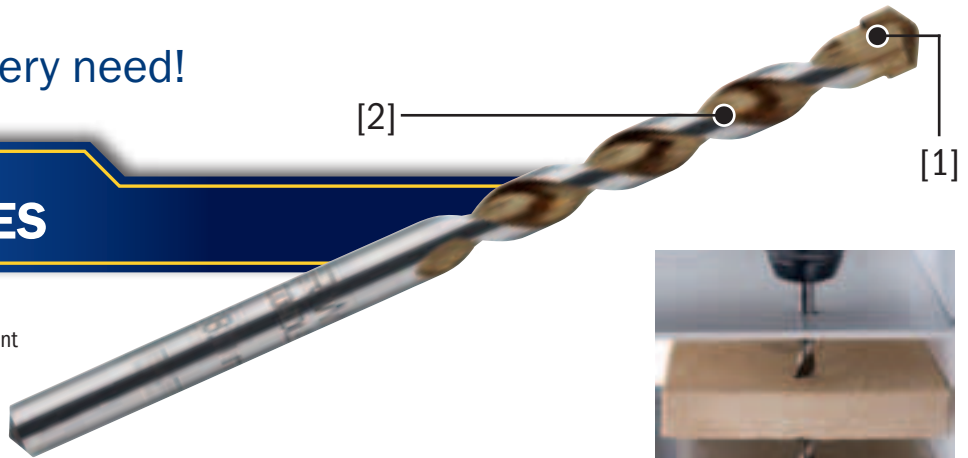

Speed Test Data

Drill Bits	Multimaterial Drill Bits
Diameter	6x160mm
Material	Floor Tile (scratch hardness 9)
Machine	Makita 18V
Hole Depth	10mm
Test Parameters	without cooling
Test Results	25% faster drilling in hardest floor tiles vs. closest competitor

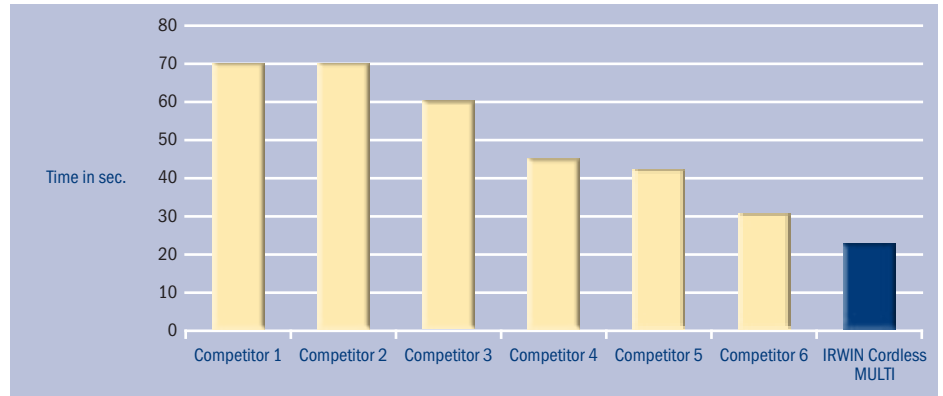

Source: Irwin Tools Test Center

Cordless MULTI Drill Bits - Straight Shank - Rotary Drilling Only

Item No.	Diameter mm	Working Length mm	Total Length mm	Shank Diameter mm	EAN	Master Pack	Shelf Pack
10501919	3,0	40	70	CYL as Ø	5709131285731	200	10
10501920	3,5	40	75	CYL as Ø	5709131285762	200	10
10501921	4,0	45	80	CYL as Ø	5709131000303	200	10
10501922	5,0	50	90	CYL as Ø	5709131000563	200	10
10501923	5,5	55	95	CYL as Ø	5709131000822	200	10
10501924	5,5	115	160	CYL as Ø	5709131055037	200	10
10501925	6,0	60	100	CYL as Ø	5709131000983	200	10
10501926	6,0	115	160	CYL as Ø	5709131001164	200	10
10501927	6,0	120	200	CYL as Ø	5709131247593	100	10
10501928	6,5	60	105	CYL as Ø	5709131001348	200	10
10501929	6,5	120	200	CYL as Ø	5709131243007	100	10
10501930	7,0	65	110	CYL as Ø	5709131001577	200	10
10501931	7,0	115	160	CYL as Ø	5709131001720	200	10
10501932	8,0	70	120	CYL as Ø	5709131001836	200	10
10501933	8,0	120	200	CYL as Ø	5709131002086	100	10
10501934	10,0	90	140	CYL as Ø	5709131002710	200	10
10501935	10,0	120	200	CYL as Ø	5709131002918	100	10
10501936	12,0	105	160	CYL as Ø	5709131003267	50	10
10501937	14,0	100	160	10	5709131003717	50	10

CORLESS MULTI



Cordless MULTI Drill Bit Cassette

Item No.	Description	EAN	Master Pack	Shelf Pack
10501938	5pcs Set : 4/5/6/8/10mm	5709131247715	60	15
10501939	5pcs Set : 5/5,5/6/8/10mm	5709131247692	60	15
10501940	7pcs Set : 4/5/6/7/8/10/12mm	5709131247708	32	8



Granite

Designed for percussion drilling in very hard materials

GRANITE FEATURES

For percussion drilling in very hard materials such as granite. Extremely hard and wear resistant carbide tip guarantees up to 40% more holes compared to conventional masonry drill bits.

Stone masons favour this product for impact drilling of natural stone like granite.

Special shaped cutting edges mean higher durability resulting in 50% more accurately sized holes per drill bit.

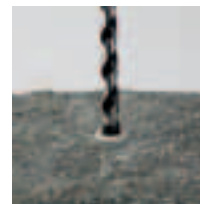

Granite Drill Bits - Straight Shank Rotary Percussion

Item No.	Diameter mm	Working Length mm	Total Length mm	Shank Diameter mm	EAN	Master Pack	Shelf Pack
10501894	3,0	40	70	CYL as Ø	5709131008095	200	10
10501895	3,5	40	75	CYL as Ø	5709131008101	200	10
10501896	4,0	45	80	CYL as Ø	5709131008118	200	10
10501897	5,0	50	90	CYL as Ø	5709131008163	200	10
10501898	5,0	115	160	CYL as Ø	5709131008187	200	10
10501899	5,5	55	95	CYL as Ø	5709131008200	200	10
10501900	5,5	115	160	CYL as Ø	5709131008224	200	10
10501901	6,0	60	100	CYL as Ø	5709131008231	200	10
10501902	6,0	115	160	CYL as Ø	5709131008255	200	10
10501903	6,5	60	105	CYL as Ø	5709131008293	200	10
10501904	6,5	115	160	CYL as Ø	5709131008316	200	10
10501905	7,0	65	110	CYL as Ø	5709131008323	200	10
10501906	7,0	115	160	CYL as Ø	5709131008347	200	10
10501907	8,0	70	120	CYL as Ø	5709131008378	200	10
10501908	8,0	130	200	CYL as Ø	5709131008392	100	10
10501909	8,5	75	125	CYL as Ø	5709131008439	200	10
10501910	9,0	80	130	CYL as Ø	5709131008446	200	10
10501911	10,0	90	140	CYL as Ø	5709131008460	200	10
10501912	10,0	130	200	CYL as Ø	5709131008491	100	10
10501913	11,0	105	160	CYL as Ø	5709131008545	50	10
10501914	12,0	105	160	CYL as Ø	5709131008552	50	10
10501915	13,0	100	160	10	5709131008606	50	10
10501916	14,0	100	160	10	5709131008613	50	10

GRANITE



Granite Drill Bit Cassettes

Item No.	Description	EAN	Master Pack	Shelf Pack
10501917	5pcs Set: 4/5/6/8/10mm	5709131248187	60	15
10501918	7pcs Set: 4/5/6/7/8/10/12mm	5709131248194	32	8



Diamond

For fast smooth cutting in all grades of hard and soft tiles.

DIAMOND USEFUL TIPS

NEW

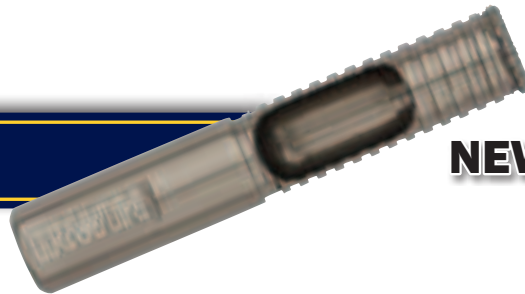

Drilling with water increases the lifespan of the tool.
Do not press strongly on the tool, let it work.

Make a swinging movement to allow dust evacuation.
Cutting speed: 2700 RPM.
No hammer action required.



1 The drill needs to run before hitting the surface. To avoid sliding of the drill, start with an angle of 45°.



2 Once the hole has started, raise the drill gradually up to the vertical line.

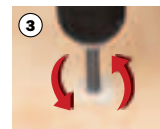

3 Make an oscillating movement while drilling.



Life Test Data

Drill Bits	Diamond Drill Bits
Diameter	10mm
Drill Bit Qty	3pcs
Material	Floor Tile (scratch hardness 9)
Machine	DW 165
RPM	2700
Hole Depth	12mm
Test Parameters	Hand Test with Water cooling
Test Results	50% more holes with Irwin Diamond Drill Bits

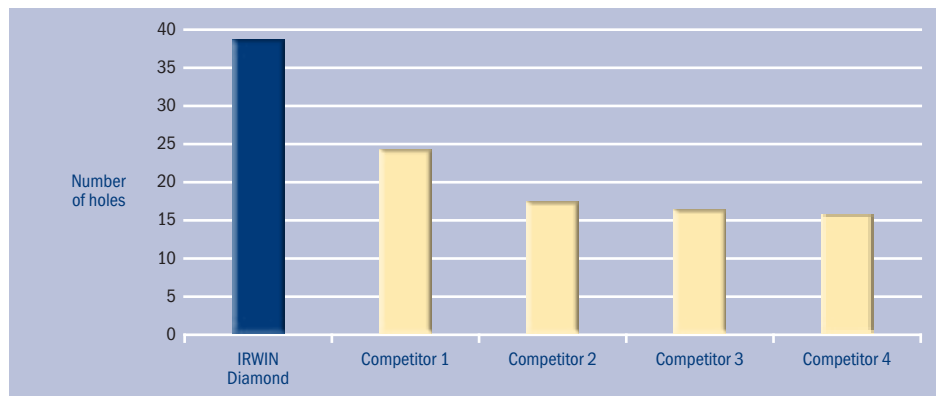

Source: Irwin Tools Test Center

Diamond Drill Bits

Item No.	Description	EAN	Master Pack	Shelf Pack
10507892	Diamond Drill BIT 5mm	5706915078923	60	1
10507893	Diamond Drill BIT 6mm	5706915078930	60	1
10507894	Diamond Drill BIT 7mm	5706915078947	60	1
10507895	Diamond Drill BIT 8mm	5706915078954	60	1
10507896	Diamond Drill BIT 10mm	5706915078961	60	1
10507897	Diamond Drill BIT 12mm	5706915078978	60	1
10507898	Diamond Drill BIT 14mm	5706915078985	60	1
10507899	Diamond Drill BIT 15mm	5706915078992	60	1
10507900	Diamond 4pcs Set: 5/6/7/8mm	5706915079005	60	1
10507901	Diamond 4pcs Set: 6/8/10/15mm	5706915079012	60	1

DIAMOND



Glass & Tile
For drilling glass, porcelain and ceramics.

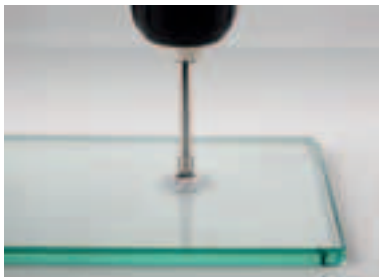

Drill with low RPM (300 RPM recommended)
Water cooling recommended.
No hammer action.



Speed Test Data

Drill Bits	Glass and Tile
Drill Bit Size	10mm
Drill Bit Qty	3pcs
Material	Ceramic Tile (scratch hardness 7)
Machine	Makita V18
RPM	450
Hole Depth	6mm
Test Parameters	Vertical Test Rig / Bias: 10kg
Test Results	2x more holes per battery charge vs. competitor products

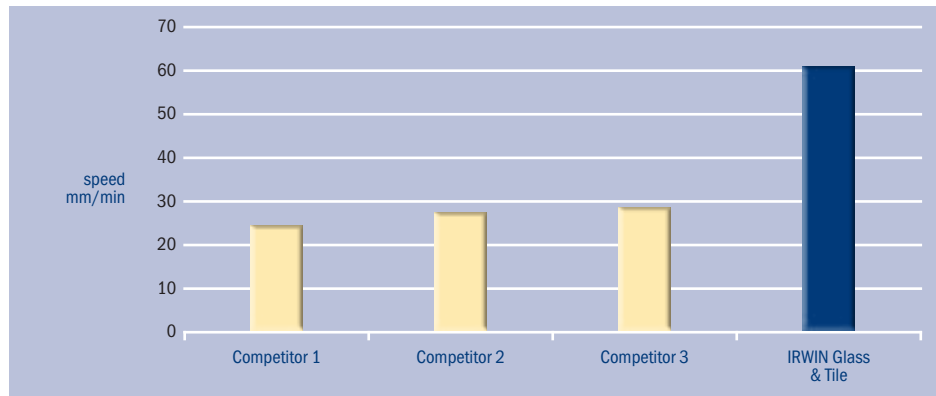

Source: Irwin Tools Test Center

Glass and Tile Drill Bits

Item No.	Description	EAN	Master Pack	Shelf Pack
10507902	Glass & Tile 3mm	5706915079029	200	10
10507903	Glass & Tile 4mm	5706915079036	200	10
10507904	Glass & Tile 5mm	5706915079043	200	10
10507905	Glass & Tile 6mm	5706915079050	200	10
10507906	Glass & Tile 7mm	5706915079067	200	10
10507907	Glass & Tile 8mm	5706915079074	200	10
10507908	Glass & Tile 9mm	5706915079081	200	10
10507909	Glass & Tile 10mm	5706915079098	200	10
10507910	Glass & Tile 12mm	5706915079104	200	10
10507911	Glass & Tile 13mm	5706915079111	200	10
10507912	Glass & Tile 5pcs Set: 4/5/6/8/10mm	5706915079128	120	10

GLASS & TILES



Metal Drilling

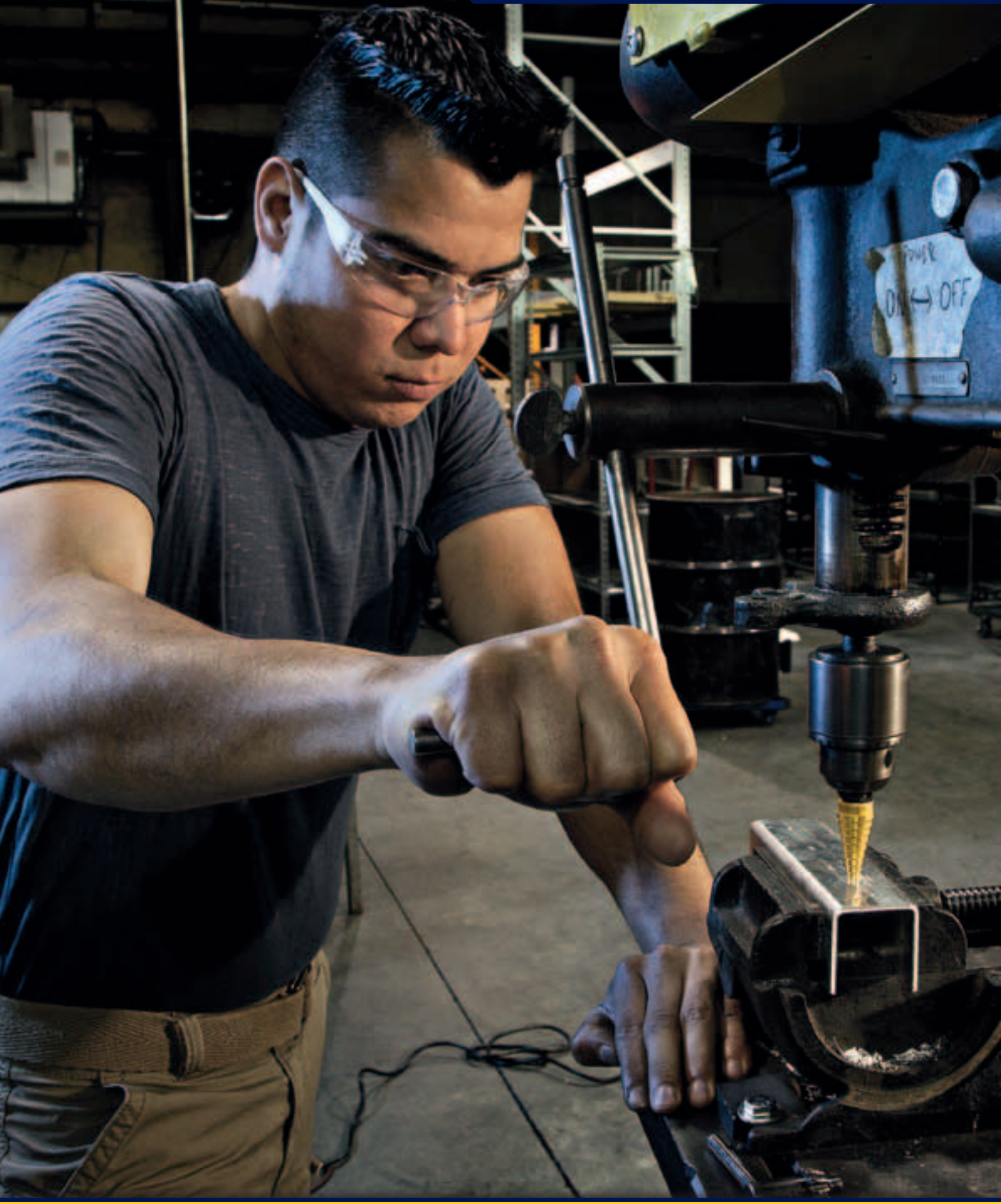

Engineered for Controlled Precision and Speed

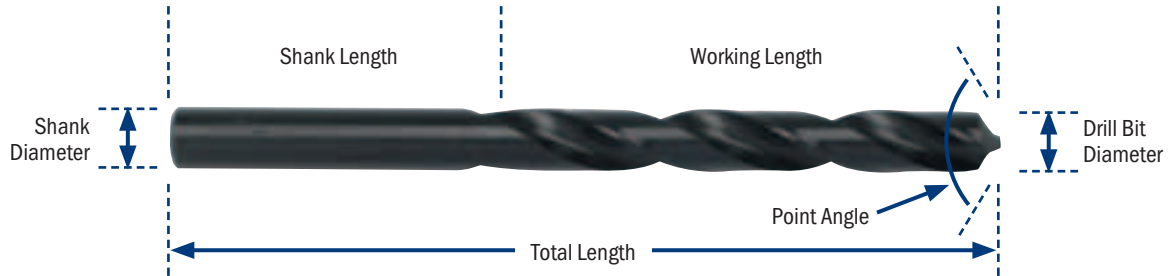

Total Length: The length from the point to the end of the drill bit

Point Angle: The angle of the cutting edges

Drill Diameter: The cutting diameter of the drill bit

Shank Length: The end of the drill bit that is secured by the drill

Working Length: The length from the point to the end of the flutes

Tip Geometry



118° Universal Point

- General use - for drilling a wide selection of materials
- Fast drilling and perfect finishing
- For stationary drills
- Performs better in softer materials than hard metal

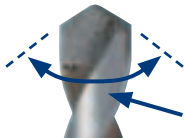

118° Point Angle

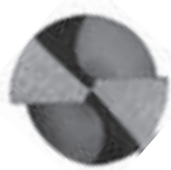

135° Split Point

- Self centring (won't 'walk')
- For portable drills
- Requires less force than 118°

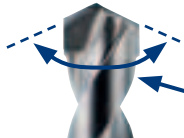

135° Point Angle



TURBOMAX® Tip

- Self centring (won't 'walk')
- Precision-ground to stay sharp longer and drill faster
- For portable drills
- Requires less force than 118°



Drill Bit Selection

Material	Point Angle	TURBOMAX®	HSS Cobalt	HSS Titanium	HSS Pro
		Jet Point	135° Split Point	135° Split Point	118° Universal Point
Wood Drywall		●	●	●	●
Sheet Metal		●	●	●	●
Mild Steel		●	●	●	●
High Alloy Steel		●	●	●	●
Stainless Steel		●	●	●	●
Cast Iron		●	●	●	●
Aluminium, Brass, Copper		●	●	●	●
Plastic		●	●	●	●

Key: ● Best Performance Recommendation ● Satisfactory Performance Recommendation ● Not Recommended

HSS Turbomax™ designed for high performance drilling

TURBOMAX FEATURES

HARDENING

- Superb wear resistance.
- Hardness of 63-66 HRC.

W9 HSS (HIGH SPEED STEEL)

- Superb heat resistance.
- Sharp cutting lips.

REINFORCED WEB

- For added strength and durability.
- Robust design - no breakage.

100° TIP FOR FASTEST START

- Most precise centering and guidance.
- No walking, also on curved surfaces.
- No centre punch necessary.

140° CUTTING SHOULDER FOR SMOOTH FINISH

- Perfectly round holes.
- Clean exit holes - minimized burrs.
- Will not bind in multiple layers of thin material.

GROUND FLUTE

- Ground from solid.

3-FLATTED SHANK

- Prevents slipping in chuck.
- No damaging of the drill due to slipping.
- Safe and strong clamping, especially when using keyless chucks.
- Best power supply to the cutting lips - spend the power where it's needed.

JET POINT - REVOLUTIONARY TIP DESIGN

- Self centering, will not walk on any surfaces.



- Turbomax™ is designed primarily for high performance drilling in sheet metal, however, also performs well in all types of wood and plastic.

- Suitable for drilling stainless steel however, HSS Cobalt products are designed specifically for this purpose.
- Remember to always use a coolant when drilling stainless steel.

Turbomax™ HSS Drill Bits

Item No.	Diameter mm	Working Length mm	Total Length mm	Pcs Per Tube	EAN	Master Pack	Shelf Pack
10502202	1,0	12	34	2pcs	5709131232889	50	10
10502203	1,5	18	40	2pcs	5709131232902	50	10
10502204	2,0	24	49	2pcs	5709131232926	50	10
10502205	2,5	30	57	2pcs	5709131232940	50	10
10502206	3,0	33	61	1pc	5709131232964	50	10
10502207	3,1	36	65	1pc	5709131232988	50	10
10502208	3,2	36	65	1pc	5709131233008	50	10
10502209	3,3	36	65	1pc	5709131233046	50	10
10502210	3,5	36	70	1pc	5709131233060	50	10
10502211	4,0	43	75	1pc	5709131233084	50	10
10502212	4,1	43	75	1pc	5709131233107	50	10
10502213	4,2	43	75	1pc	5709131233121	50	10
10502214	4,3	43	75	1pc	5709131233541	50	10
10502215	4,5	47	80	1pc	5709131233145	50	10
10502216	4,8	41	86	1pc	5709131233169	50	10
10502217	4,9	41	86	1pc	5709131233183	50	10
10502218	5,0	41	86	1pc	5709131233206	50	10
10502219	5,1	41	86	1pc	5709131233220	50	10
10502220	5,5	48	93	1pc	5709131233244	50	10
10502221	6,0	48	93	1pc	5709131233268	50	10
10502222	6,5	56	101	1pc	5709131233282	50	10
10502223	7,0	62	109	1pc	5709131233305	50	10
10502224	7,5	62	109	1pc	5709131233329	50	10
10502225	8,0	70	117	1pc	5709131233367	50	10



Turbomax™ HSS Drill Bits

Item No.	Diameter mm	Working Length mm	Total Length mm	Pcs Per Tube	EAN	Master Pack	Shelf Pack
10502226	8,5	70	117	1pc	5709131233381	50	10
10502227	9,0	78	125	1pc	5709131233404	50	10
10502228	9,5	78	125	1pc	5709131233428	50	10
10502229	10,0	83	133	1pc	5709131233442	50	10
10502230	11,0	92	142	1pc	5709131233466	30	10
10502231	12,0	101	151	1pc	5709131233480	30	10
10502232	13,0	101	151	1pc	5709131233503	30	10



Turbomax™ HSS Drill Bit Cassettes

Item No.	Description	EAN	Master Pack	Shelf Pack
10502233	Turbomax™ 19pcs Set in metal case: 1,0 - 10,0mm in steps of 0,5mm	5709131240693	5	1
10502234	Turbomax™ 5pc Set in plastic cassette: 4 / 5 / 6 / 8 / 10mm	5709131266167	15	1
10503992	Turbomax™ 15pcs Set: 1,5 / 2,0 / 2,5 / 3,0 / 3,5 / 4,0 / 4,5 / 5,0 / 5,5 / 6,0 / 6,5 / 7,0 / 8,0 / 9,0 / 10,0mm	5706915039924	6	1



HSS Cobalt designed for drilling stainless steel

HSS COBALT FEATURES

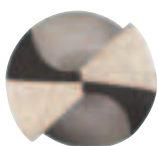

SURFACE FINISH

Attractive golden tempered surface

GROUND FLUTE

Industrial quality ground flute for high accuracy drilling and fast removal of chips.

135° SPLIT POINT GRINDING

ensures perfect centring and reduced drilling pressure

COBALT ALLOYED

Drill bit body manufactured from high quality HSS steel containing 5% Cobalt (Co).

The added 5% Cobalt improves the red hardness (heat resistance) of the drill bit and results in significantly extended life.

- **5% Cobalt** for higher heat and abrasion resistance.
- **Heavy-duty** web construction for strength and durability.
- **135° split point** begins drilling immediately, minimizing bit “walk”.
- **Manufactured to** DIN 338 Standards.

Applications:

Tough metal drilling, including heavy-duty abrasive alloy metal drilling on hardened steel (heat-treated).

HSS Cobalt Drill Bits

Item No.	Diameter mm	Working Length mm	Total Length mm	Pcs Per Tube	EAN	Master Pack	Shelf Pack
10502507	1.0	12	34	2pcs	5709131282532	200	10
10502508	1.5	18	40	2pcs	5709131282570	200	10
10502509	2.0	24	49	2pcs	5709131282617	200	10
10502510	2.5	30	57	2pcs	5709131282655	200	10
10502542	3.0	33	61	1pc	5709131282693	200	10
10502543	3.1	36	65	1pc	5709131282730	200	10
10502544	3.2	36	65	1pc	5709131282778	200	10
10502545	3.3	36	65	1pc	5709131282815	200	10
10502546	3.5	39	70	1pc	5709131282853	200	10
10502547	4.0	43	75	1pc	5709131282891	200	10
10502548	4.1	43	75	1pc	5709131282938	200	10
10502549	4.2	43	75	1pc	5709131282976	200	10
10502550	4.3	47	80	1pc	5709131283010	200	10
10502551	4.5	47	80	1pc	5709131283058	200	10
10502552	4.8	52	86	1pc	5709131283096	200	10
10502553	4.9	52	86	1pc	5709131283133	200	10
10502554	5.0	52	86	1pc	5709131283171	200	10
10502555	5.1	52	86	1pc	5709131283218	200	10
10502556	5.5	57	93	1pc	5709131283256	200	10
10502557	6.0	57	93	1pc	5709131283294	200	10
10502558	6.5	63	101	1pc	5709131283331	100	10
10502559	7.0	69	109	1pc	5709131283379	100	10
10502560	7.5	69	109	1pc	5709131283416	100	10
10502561	8.0	75	117	1pc	5709131283454	100	10
10502562	8.5	75	117	1pc	5709131283492	100	10
10502563	9.0	81	125	1pc	5709131283539	100	10
10502564	9.5	81	125	1pc	5709131283577	100	10
10502565	10.0	87	133	1pc	5709131283614	100	10
10502566	11.0	94	142	1pc	5709131283652	50	10
10502567	12.0	101	151	1pc	5709131283690	50	10
10502568	13.0	101	151	1pc	5709131283737	50	10



HSS Cobalt Drill Bits Bulk Pack



Item No.	Diameter mm	Working Length mm	Total Length mm	Pcs Per Pack	EAN	Master Pack	Shelf Pack
10502511	1,0	12	34	10pcs	5706915000450	50	1
10502512	1,5	18	40	10pcs	5706915000474	50	1
10502513	2,0	24	49	10pcs	5706915000498	50	1
10503595	2,25	24	49	10pcs	5706915035957	50	1
10502514	2,5	30	57	10pcs	5706915000511	50	1
10502515	3,0	33	61	10pcs	5706915000535	50	1
10502516	3,1	36	65	10pcs	5706915000559	50	1
10502517	3,2	36	65	10pcs	5706915000573	50	1
10503596	3,25	36	65	10pcs	5706915035964	50	1
10502518	3,3	36	65	10pcs	5706915000597	50	1
10502519	3,5	39	70	10pcs	5706915000610	50	1
10502520	4,0	43	75	10pcs	5706915000634	50	1
10502521	4,1	43	75	10pcs	5706915000658	50	1
10502522	4,2	43	75	10pcs	5706915000672	50	1
10503597	4,25	43	75	10pcs	5706915035971	50	1
10502523	4,3	47	80	10pcs	5706915000696	50	1
10502524	4,5	47	80	10pcs	5706915000719	50	1
10502525	4,8	52	86	10pcs	5706915000733	50	1
10502526	4,9	52	86	10pcs	5706915000757	50	1
10502527	5,0	52	86	10pcs	5706915000771	50	1
10502528	5,1	52	86	10pcs	5706915000795	50	1
10503598	5,25	52	86	10pcs	5706915035988	50	1
10502529	5,5	57	93	10pcs	5706915000818	20	1
10502530	6,0	57	93	10pcs	5706915000832	50	1
10502531	6,5	63	101	10pcs	5706915000856	20	1
10503600	6,75	63	101	10pcs	5706915036008	20	1
10502532	7,0	69	109	10pcs	5706915000894	20	1
10502533	7,5	69	109	5pcs	5706915000870	40	1
10503601	7,75	69	109	5pcs	5706915036015	40	1
10502534	8,0	75	117	5pcs	5706915000917	40	1
10502535	8,5	75	117	5pcs	5706915000931	40	1
10502536	9,0	81	125	5pcs	5706915000955	40	1
10502537	9,5	81	125	5pcs	5706915000979	40	1
10502538	10,0	87	133	5pcs	5706915000993	40	1
10503602	10,25	87	133	5pcs	5706915036022	40	1
10502539	11,0	94	142	5pcs	5706915001013	20	1
10502540	12,0	101	151	5pcs	5706915001037	20	1
10502541	13,0	101	151	5pcs	5706915001051	20	1

HSS Pro Cobalt Drill Bit Sets



Item No.	Description	EAN	Master Pack	Shelf Pack
10503730	HSS Cobalt 25pcs Set in metal case: 1,0 - 13,0mm in steps of 0,5mm	5706915037302	4	1
10502569	HSS Cobalt 19pcs Set in metal case: 1,0 - 10,0mm in steps of 0,5mm	5709131282433	25	5
10502570	HSS Cobalt 5pcs Set in plastic cassette: 4 / 5 / 6 / 8 / 10mm	5709131282464	45	15
10503990	HSS Cobalt 15pcs Set: 1,5 / 2,0 / 2,5 / 3,0 / 3,5 / 4,0 / 4,5 / 5,0 / 5,5 / 6,0 / 6,5 / 7,0 / 8,0 / 9,0 / 10,0mm	5706915039900	6	1

HSS Titanium fast and precise

HSS TITANIUM FEATURES

SPEED AND FEED

Compared to traditional HSS Twist Drill Bits speed can be increased by 40 -60% and feed by 10 -20% without reducing the life time of the drill bit significantly.

LESS HEAT

TiN is also a poor conductor of heat, so the heat generated during the drilling process is diverted into the chips and coolant and less into the drill bit.

GROUND FLUTE

Industrial quality ground flute for high accuracy drilling and fast removal of chips.

135° SPLIT POINT GRINDING

ensures perfect centring and reduced drilling pressure

TITANIUM NITRIDE COATED

- Drill bit body manufactured from high quality HSS steel coated with 2.5µ Titanium Nitride (TiN).
- The TiN coating has a hardness of app. 80 HRC and is very resistant to wear.
- TiN has a low coefficient of friction. This results in less power being consumed and less heat generated during the drilling

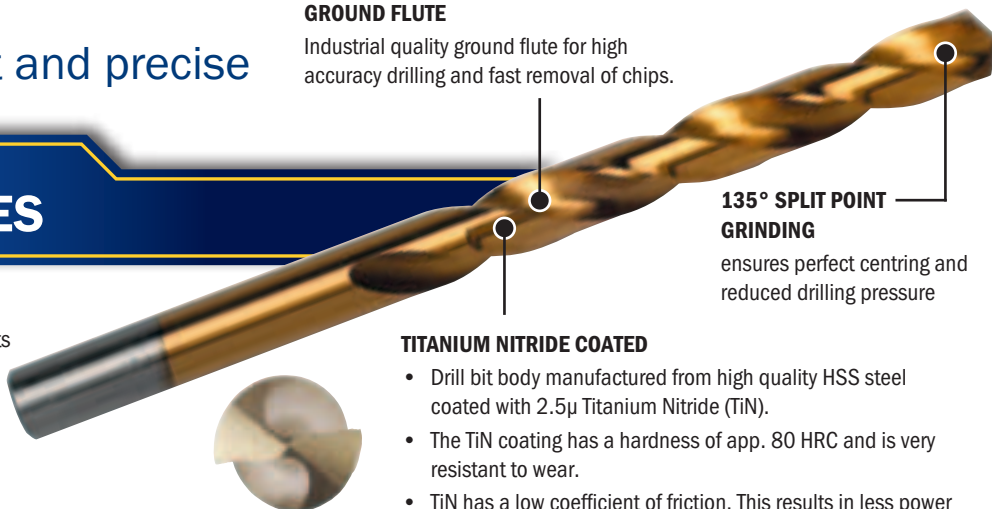

- **Titanium Nitride coated bits** last up to six times longer than standard high speed steel drill bits
- **Cutting edge** stays sharper longer
- **Titanium Nitride** coating reduces friction
- **Manufactured to** DIN 338 Standards

Applications:

Repetitive metal drilling with Portable Drills, Stationary Drill Presses

HSS Titanium Drill Bits

Item No.	Diameter mm	Working Length mm	Total Length mm	Pcs Per Tube	EAN	Master Pack	Shelf Pack
10502572	1,0	12	34	2pcs	5709131282556	200	10
10502573	1,5	18	40	2pcs	5709131282594	200	10
10502574	2,0	24	49	2pcs	5709131282631	200	10
10502575	2,5	30	57	2pcs	5709131282679	200	10
10502576	3,0	33	61	1pc	5709131282716	200	10
10502577	3,1	36	65	1pc	5709131282754	200	10
10502578	3,2	36	65	1pc	5709131282792	200	10
10502579	3,3	36	65	1pc	5709131282839	200	10
10502580	3,5	39	70	1pc	5709131282877	200	10
10502581	4,0	43	75	1pc	5709131282914	200	10
10502582	4,1	43	75	1pc	5709131282952	200	10
10502583	4,2	43	75	1pc	5709131282990	200	10
10502584	4,3	47	80	1pc	5709131283034	200	10
10502585	4,5	47	80	1pc	5709131283072	200	10
10502586	4,8	52	86	1pc	5709131283119	200	10
10502587	4,9	52	86	1pc	5709131283157	200	10
10502588	5,0	52	86	1pc	5709131283195	200	10
10502589	5,1	52	86	1pc	5709131283232	200	10
10502590	5,5	57	93	1pc	5709131283270	200	10
10502591	6,0	57	93	1pc	5709131283317	200	10
10502592	6,5	63	101	1pc	5709131283355	100	10
10502593	7,0	69	109	1pc	5709131283393	100	10



HSS Titanium Drill Bits

Item No.	Diameter mm	Working Length mm	Total Length mm	Pcs Per Tube	EAN	Master Pack	Shelf Pack
10502594	7,5	69	109	1pc	5709131283430	100	10
10502595	8,0	75	117	1pc	5709131283478	100	10
10502596	8,5	75	117	1pc	5709131283515	100	10
10502597	9,0	81	125	1pc	5709131283553	100	10
10502598	9,5	81	125	1pc	5709131283591	100	10
10502599	10,0	87	133	1pc	5709131283638	100	10
10502600	11,0	94	142	1pc	5709131283676	50	10
10502601	12,0	101	151	1pc	5709131283713	50	10
10502602	13,0	101	151	1pc	5709131283751	50	10



HSS Titanium Drill Bit Sets

Item No.	Description	EAN	Master Pack	Shelf Pack
10502603	HSS Titanium 19pcs Set in metal case: 1,0 - 10,0mm in steps of 0,5mm	5709131282440	25	5
10502604	HSS Titanium 5pcs Set in plastic cassette: 4 / 5 / 6 / 8 / 10mm	5709131282471	45	15
10503991	HSS Titanium 15pcs Set: 1,5 / 2,0 / 2,5 / 3,0 / 3,5 / 4,0 / 4,5 / 5,0 / 5,5 / 6,0 / 6,5 / 7,0 / 8,0 / 9,0 / 10,0mm	5706915039917	6	1



HSS Pro designed for drilling a wide selection of materials

HSS PRO

FEATURES

HSS STEEL

Drill bit body manufactured from high quality HSS steel with steam oxide surface finish.

PRECISION GROUND CUTTING EDGES

for fast drilling and perfect finishing.

UNIVERSAL 118° POINT SHAPE

for drilling a wide selection of materials.

GROUND FLUTE

for maximum accuracy and fast chip removal.

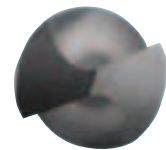

- **Ground Quality**
- **Manufactured** to DIN 338 Standards
- **Cylindrical** Shank
- **Universal 118° point shape** for drilling a wide selection of materials
- **Precision ground cutting edges** for fast drilling and perfect finishing
- **Ground flute** for maximum accuracy and fast chip removal

HSS Pro Drill Bits

Item No.	Diameter mm	Working Length mm	Total Length mm	Pcs Per Tube	EAN	Master Pack	Shelf Pack
10502376	1,00	12	34	3pcs	5709131104674	200	10
10502377	1,50	18	40	3pcs	5709131104865	200	10
10502378	2,00	24	49	3pcs	5709131105084	200	10
10502379	2,50	30	57	3pcs	5709131105251	200	10
10502380	3,00	33	61	3pcs	5709131105466	200	10
10502381	3,20	36	65	2pcs	5709131105589	200	10
10502382	3,30	36	65	2pcs	5709131105657	200	10
10502383	3,50	39	70	2pcs	5709131105732	200	10
10502384	4,00	43	75	2pcs	5709131105930	200	10
10502385	4,20	43	75	2pcs	5709131106050	200	10
10502386	4,50	47	80	2pcs	5709131106166	200	10
10502387	5,00	52	86	2pcs	5709131106371	200	10
10502388	5,50	57	93	1pc	5709131106555	200	10
10502389	6,00	57	93	1pc	5709131106753	200	10
10502390	6,50	63	101	1pc	5709131106944	200	10
10502391	7,00	69	109	1pc	5709131107101	100	10
10502392	7,50	69	109	1pc	5709131107279	100	10
10502393	8,00	75	117	1pc	5709131107477	100	10
10502394	8,50	75	117	1pc	5709131107668	100	10
10502395	9,00	81	125	1pc	5709131107842	100	10
10502396	9,50	81	125	1pc	5709131108016	100	10
10502397	10,00	87	133	1pc	5709131108207	100	10



HSS Pro Drill Bits - Reduced Shank

Item No.	Diameter mm	Working Length mm	Total Length mm	Shank Diameter mm	EAN	Master Pack	Shelf Pack
10502398	10,50	87	133	10mm	5709131108429	100	10
10502399	11,00	94	142	10mm	5709131108597	50	10
10502400	11,50	94	142	10mm	5709131108764	50	10
10502401	12,00	101	151	10mm	5709131108948	50	10
10502402	12,50	101	151	10mm	5709131109099	50	10
10502403	13,00	101	151	10mm	5709131109266	50	10
10502404	13,50	108	160	10mm	5709131109402	50	10
10502405	14,00	108	160	10mm	5709131109471	50	10
10502406	14,50	114	169	10mm	5709131109570	25	10
10502407	15,00	114	169	10mm	5709131109662	25	5
10502408	15,50	120	178	10mm	5709131109730	25	5
10502409	16,00	120	178	10mm	5709131109822	25	5
10502410	16,50	125	184	13mm	5709131109921	25	5
10502411	17,00	125	184	13mm	5709131109990	25	5
10502412	17,50	130	191	13mm	5709131110064	25	5
10502413	18,00	130	191	13mm	5709131110132	25	5
10502414	18,50	135	198	13mm	5709131110200	25	5
10502415	19,00	135	198	13mm	5709131110286	25	5
10502416	19,50	140	205	13mm	5709131110354	25	5
10502417	20,00	140	205	13mm	5709131110439	25	5



HSS Pro Drill Bits Bulk Pack

Item No.	Diameter mm	Working Length mm	Total Length mm	Pcs Per Pack	EAN	Master Pack	Shelf Pack
10502236	0,50	6	22	10pcs	5709131035923	50	1
10502237	0,60	7	24	10pcs	5709131035954	50	1
10502238	0,70	9	28	10pcs	5709131035978	50	1
10502239	0,80	10	30	10pcs	5709131035992	50	1
10502240	0,90	11	32	10pcs	5709131036012	50	1
10502241	1,00	12	34	10pcs	5709131036043	50	1
10502242	1,10	14	36	10pcs	5709131036098	50	1
10502243	1,20	16	38	10pcs	5709131036128	50	1
10502244	1,30	16	38	10pcs	5709131036159	50	1
10502245	1,40	18	40	10pcs	5709131036180	50	1
10502246	1,50	18	40	10pcs	5709131036210	50	1
10502247	1,60	20	43	10pcs	5709131036272	50	1
10502248	1,70	20	43	10pcs	5709131036302	50	1
10502249	1,80	22	46	10pcs	5709131036326	50	1
10502250	1,90	22	46	10pcs	5709131036357	50	1
10502251	2,00	24	49	10pcs	5709131036401	50	1
10502252	2,10	24	49	10pcs	5709131036463	50	1
10502253	2,20	27	53	10pcs	5709131036487	50	1
10503586	2,25	27	53	10pcs	5706915035865	50	1
10502254	2,30	27	53	10pcs	5709131036517	50	1
10502255	2,40	30	57	10pcs	5709131036548	50	1
10502256	2,50	30	57	10pcs	5709131036562	50	1
10502257	2,60	33	57	10pcs	5709131036623	50	1
10502258	2,70	33	61	10pcs	5709131036654	50	1
10502259	2,80	33	61	10pcs	5709131036685	50	1
10502260	2,90	33	61	10pcs	5709131036708	50	1
10502261	3,00	33	61	10pcs	5709131036746	50	1
10502262	3,10	36	65	10pcs	5709131036814	50	1
10502263	3,20	36	65	10pcs	5709131036852	50	1
10503587	3,25	36	65	10pcs	5706915035872	50	1
10502264	3,30	36	65	10pcs	5709131036906	50	1
10502265	3,40	39	70	10pcs	5709131036944	50	1
10502266	3,50	39	70	10pcs	5709131036968	50	1
10502267	3,60	39	70	10pcs	5709131037033	50	1
10502268	3,70	39	70	10pcs	5709131037057	50	1
10502269	3,80	43	75	10pcs	5709131037071	50	1



HSS Pro Drill Bits Bulk Pack

Item No.	Diameter mm	Working Length mm	Total Length mm	Pcs Per Pack	EAN	Master Pack	Shelf Pack
10502270	3,90	43	75	10pcs	5709131037095	50	1
10502271	4,00	43	75	10pcs	5709131231202	50	1
10502272	4,10	43	75	10pcs	5709131037200	50	1
10502273	4,20	43	75	10pcs	5709131037231	50	1
10503588	4,25	43	75	10pcs	5706915035889	50	1
10502274	4,30	47	80	10pcs	5709131037262	50	1
10502275	4,40	47	80	10pcs	5709131037293	50	1
10502276	4,50	47	80	10pcs	5709131037316	50	1
10502277	4,60	47	80	10pcs	5709131037378	50	1
10502278	4,70	47	80	10pcs	5709131037392	50	1
10502279	4,80	52	86	10pcs	5709131037439	50	1
10502280	4,90	52	86	10pcs	5709131037460	50	1
10502281	5,00	52	86	10pcs	5709131037491	50	1
10502282	5,10	52	86	10pcs	5709131037569	50	1
10502283	5,20	52	86	10pcs	5709131037606	50	1
10503589	5,25	52	86	10pcs	5706915035896	50	1
10502284	5,30	52	86	10pcs	5709131037620	50	1
10502285	5,40	57	93	10pcs	5709131037644	50	1
10502286	5,50	57	93	10pcs	5709131037668	50	1
10502287	5,60	57	93	10pcs	5709131037729	50	1
10502288	5,70	57	93	10pcs	5709131037743	50	1
10502289	5,80	57	93	10pcs	5709131037774	50	1
10502290	5,90	57	93	10pcs	5709131037798	50	1
10502291	6,00	57	93	10pcs	5709131037835	50	1
10502292	6,10	63	101	10pcs	5709131037903	40	1
10502293	6,20	63	101	10pcs	5709131037934	40	1
10502294	6,30	63	101	10pcs	5709131037958	40	1
10502295	6,40	63	101	10pcs	5709131037989	40	1
10502296	6,50	63	101	10pcs	5709131038016	40	1
10502297	6,60	63	101	10pcs	5709131038061	40	1
10502299	6,80	69	109	10pcs	5709131038115	40	1
10502300	6,90	69	109	10pcs	5709131038139	40	1
10502301	7,00	69	109	10pcs	5709131038153	40	1
10502302	7,10	69	109	5pcs	5709131038207	40	1
10502303	7,20	69	109	5pcs	5709131038238	40	1
10502304	7,30	69	109	5pcs	5709131038269	40	1
10502305	7,40	69	109	5pcs	5709131038283	40	1
10502306	7,50	69	109	5pcs	5709131038306	40	1
10502307	7,60	75	117	5pcs	5709131038368	40	1
10502308	7,70	75	117	5pcs	5709131038382	40	1
10503592	7,75	75	117	5pcs	5706915035926	40	1
10502309	7,80	75	117	5pcs	5709131038405	40	1
10502310	7,90	75	117	5pcs	5709131038429	40	1
10502311	8,00	75	117	5pcs	5709131038474	40	1
10502312	8,10	75	117	5pcs	5709131038559	40	1
10502313	8,20	75	117	5pcs	5709131038580	40	1
10502314	8,30	75	117	5pcs	5709131038603	40	1
10502315	8,40	75	117	5pcs	5709131038634	40	1
10502316	8,50	75	117	5pcs	5709131038658	40	1
10502317	8,60	81	125	5pcs	5709131038702	40	1
10502318	8,70	81	125	5pcs	5709131038733	40	1
10502319	8,80	81	125	5pcs	5709131038764	40	1
10502320	8,90	81	125	5pcs	5709131038788	40	1
10502321	9,00	81	125	5pcs	5709131038818	40	1
10502322	9,10	81	125	5pcs	5709131038863	40	1
10502323	9,20	81	125	5pcs	5709131038894	40	1
10502324	9,30	81	125	5pcs	5709131038917	40	1
10502325	9,40	81	125	5pcs	5709131038931	40	1
10502326	9,50	81	125	5pcs	5709131038962	40	1
10502327	9,60	87	133	5pcs	5709131039020	40	1
10502328	9,70	87	133	5pcs	5709131039051	40	1
10502329	9,80	87	133	5pcs	5709131039075	40	1



HSS Pro Drill Bits Bulk Pack

Item No.	Diameter mm	Working Length mm	Total Length mm	Pcs Per Pack	EAN	Master Pack	Shelf Pack
10502330	9,90	87	133	5pcs	5709131039099	40	1
10502331	10,00	87	133	5 pcs	5709131039129	40	1
10502332	10,10	87	133	5 pcs	5709131039198	20	1
10502333	10,20	87	133	5 pcs	5709131039211	20	1
10503593	10,25	87	133	5 pcs	5706915935936	20	1
10502334	10,30	87	133	5 pcs	5709131039242	20	1
10502335	10,40	87	133	5 pcs	5709131039273	20	1
10502336	10,50	87	133	5 pcs	5709131039297	20	1
10502337	10,60	87	133	5 pcs	5709131039365	20	1
10502338	10,70	94	142	5 pcs	5709131039389	20	1
10502339	10,80	94	142	5 pcs	5709131163114	20	1
10502340	10,90	94	142	5 pcs	5709131039419	20	1
10502341	11,00	94	142	5 pcs	5709131039433	20	1
10502342	11,10	94	142	5 pcs	5709131039501	20	1
10502343	11,20	94	142	5 pcs	5709131039525	20	1
10502344	11,30	94	142	5 pcs	5709131039549	20	1
10502345	11,40	94	142	5 pcs	5709131039563	20	1
10502346	11,50	94	142	5 pcs	5709131039587	20	1
10502348	11,70	94	142	5 pcs	5709131039679	20	1
10502349	11,80	94	142	5 pcs	5709131039686	20	1
10502350	11,90	101	151	5 pcs	5709131039709	20	1
10502351	12,00	101	151	5 pcs	5709131039723	20	1
10502352	12,10	101	151	5 pcs	5709131039792	20	1
10502353	12,20	101	151	5 pcs	5709131039822	20	1
10502355	12,40	101	151	5 pcs	5709131039853	20	1
10502356	12,50	101	151	5 pcs	5709131039877	20	1
10502357	12,60	101	151	5pcs	5709131039921	20	1
10502358	12,70	101	151	5pcs	5709131039945	20	1
10502360	12,90	101	151	5pcs	5709131039990	20	1
10502361	13,00	101	151	5pcs	5709131040002	20	1
10502362	13,50	108	160	5pcs	5709131040125	20	1
10502363	14,00	108	160	1pc	5709131040163	20	1
10502364	14,50	114	169	1pc	5709131040200	25	1
10502365	15,00	114	169	1pc	5709131040262	25	1
10502366	15,50	120	178	1pc	5709131040316	25	1
10502367	16,00	120	178	1pc	5709131040354	25	1
10502368	16,50	125	184	1pc	5709131040408	25	1
10502369	17,00	125	184	1pc	5709131040460	25	1
10502370	17,50	130	191	1pc	5709131040507	25	1
10502371	18,00	130	191	1pc	5709131040545	25	1
10502372	18,50	135	198	1pc	5709131040583	25	1
10502373	19,00	135	198	1pc	5709131040620	25	1
10502374	19,50	140	205	1pc	5709131040675	25	1
10502375	20,00	140	205	1pc	5709131040712	25	1





HSS Pro Long Drill Bits Bulk Pack

Item No.	Diameter mm	Working Length mm	Total Length mm	Pcs Per Pack	EAN	Master Pack	Shelf Pack
10504413	1,0	33	56	10pcs	5706915944136	-	1
10504414	1,5	45	70	10pcs	5706915944143	-	1
10502482	2,0	55	85	10pcs	5709131061755	-	1
10502483	2,5	65	100	10pcs	5709131041931	-	1
10502484	3,0	70	110	10pcs	5709131041948	-	1
10504415	3,1	69	106	10pcs	5706915944150	-	1
10503855	3,2	69	106	10pcs	5706915938555	-	1
10502485	3,5	80	120	10pcs	5709131041955	-	1
10502486	4,0	80	120	10pcs	5709131041962	-	1
10503856	4,2	78	119	10pcs	5706915938562	-	1
10502487	4,5	85	130	10pcs	5709131041986	-	1
10504418	4,8	87	132	10pcs	5706915944181	-	1
10504419	4,9	87	132	10pcs	5706915944198	-	1
10502488	5,0	90	135	10pcs	5709131041993	-	1
10504420	5,2	87	132	10pcs	5706915944204	-	1
10502489	5,5	95	140	10pcs	5709131042013	-	1
10502490	6,0	95	140	10pcs	5709131042020	-	1
10502491	6,5	100	150	10pcs	5709131111856	-	1
10502492	7,0	100	150	10pcs	5709131042037	-	1
10502493	7,5	105	160	5pcs	5709131061762	20	1
10503857	7,7	109	165	5pcs	5706915938579	20	1
10502494	8,0	105	160	5pcs	5709131042044	20	1
10502495	8,5	105	160	5pcs	5709131231271	20	1
10502496	9,0	110	170	5pcs	5709131061786	20	1
10502497	9,5	115	175	5pcs	5709131061793	20	1
10502498	10,0	115	175	5pcs	5709131042051	20	1
10503858	12,0	134	205	5pcs	5706915938586	20	1



HSS Pro Double-Ended Drill Bits 10 Piece Bulk Pack

Item No.	Description	Pcs Per Pack	EAN	Master Pack	Shelf Pack
10502479	3,30mm Double-Ended	10pcs	5709131041559	50	1
10502480	4,10mm Double-Ended	10pcs	5709131041634	50	1
10502481	4,90mm Double-Ended	10pcs	5709131041702	50	1

HSS Pro Drill Bits Sets

Item No.	Description	EAN	Master Pack	Shelf Pack
10502499	HSS Pro 5pcs Set in plastic cassette: 4 / 5 / 6 / 8 / 10mm	5709131282457	60	15
10502500	HSS Pro 19pcs Set in metal case (E1): 1,0 - 10,0mm in steps of 0,5mm	5709131284628	20	5
10502504	HSS Pro 25pcs Set in metal case (G1): 1,0 - 13,0mm in steps of 0,5mm	5709131284659	16	4
10503989	HSS Pro 15pcs Set: 1,5 / 2,0 / 2,5 / 3,0 / 3,5 / 4,0 / 4,5 / 5,0 / 5,5 / 6,0 / 6,5 / 7,0 / 8,0 / 9,0 / 10,0mm	5706915039894	6	1
10503993	15pcs Set: HSS Pro: 2,0 / 3,0 / 3,5 / 4,0 / 5,0 / 6,0 / 8,0mm; Cordless Multi: 4,0 / 5,0 / 6,0 / 8,0mm; Brad Point: 3,0 / 4,0 / 6,0 / 8,0mm	5706915039931	6	1



TCT designed for drilling hard and abrasive materials

TCT FEATURES

COOLANT

A coolant should always be used when drilling with TCT Twist Drill Bits. It is recommended to use a 3-6% emulsion. The coolant will extend the life time of the drill bit.

DRILL BIT BODY

Drill bit body made from Chrome Vanadium Steel. Hardened to 56 HRC.

FLUTE

Extra deep ground double flutes for extra chip capacity.

CARBIDE TIP

Carbide Tip will drill hardened material up to a hardness of 50 HRC. Four faceted ground for low drilling pressure and perfect centring.

BODY CLEARANCE

Reduced flute land means less friction.

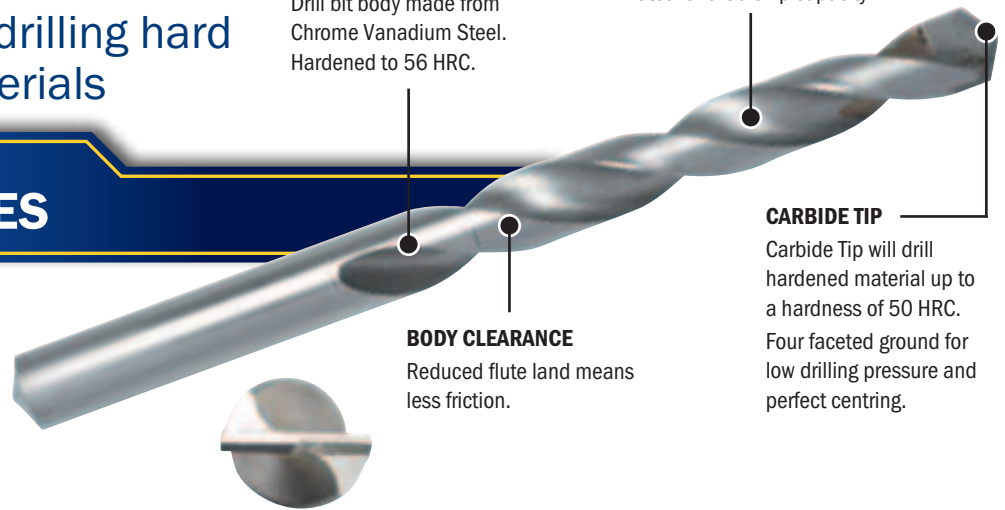

- **Manufactured to DIN 338 Standards**
- **Designed for drilling of hard and very abrasive materials** like hardened steel, cast iron etc

- **Diamond-ground 4-facet carbide tip** for easy centring and low drilling pressure
- **Designed for use in stationary drills**

TCT Drill Bits - Straight Shank

Item No.	Diameter mm	Working Length mm	Total Length mm	EAN	Master Pack	Shelf Pack
10502618	2,00	24	51	5709131042235	50	10
10502619	2,50	30	57	5709131042372	50	10
10502620	3,00	33	61	5709131042549	50	10
10502621	3,10	39	70	5709131042570	50	10
10502622	3,20	39	70	5709131042617	50	10
10502624	3,30	39	70	5709131042662	50	10
10502626	3,50	39	70	5709131042723	50	10
10502627	3,60	43	75	5709131042761	50	10
10502631	4,00	43	75	5709131042907	50	10
10502633	4,20	47	80	5709131042976	50	10
10502634	4,30	47	80	5709131043010	50	10
10502636	4,50	47	80	5709131043089	50	10
10502641	5,00	52	86	5709131043270	50	10
10502642	5,10	57	93	5709131043324	50	10
10502643	5,20	57	93	5709131043362	50	10
10502644	5,30	57	93	5709131043409	50	10
10502646	5,50	57	93	5709131043461	50	10
10502649	5,80	57	93	5709131043577	50	10
10502651	6,00	57	93	5709131043645	50	10
10502656	6,50	63	101	5709131043829	50	10
10502658	6,70	69	109	5709131043881	50	10
10502659	6,80	69	109	5709131043935	50	10
10502661	7,00	69	109	5709131043980	50	10
10502662	7,10	69	109	5709131044017	50	10
10502666	7,50	69	109	5709131044147	50	10
10502671	8,00	75	117	5709131044307	50	10
10502676	8,50	75	117	5709131044475	50	10
10502680	9,00	81	125	5709131044659	50	10
10502685	9,50	81	125	5709131044772	50	10
10502689	10,00	87	133	5709131044949	50	10



TCT Drill Bits - Straight Shank

Item No.	Diameter mm	Working Length mm	Total Length mm	EAN	Master Pack	Shelf Pack
10502690	10,50	87	133	5709131045137	30	10
10502691	11,00	94	142	5709131045274	30	10
10502692	11,50	94	142	5709131045397	30	10
10502693	12,00	101	151	5709131045564	30	10
10502694	12,50	101	151	5709131045700	30	10
10502695	13,00	101	151	5709131045847	30	10
10502696	13,50	108	160	5709131045892	30	10
10502697	14,00	108	160	5709131045922	30	10
10502699	15,00	114	169	5709131045991	15	5
10502701	16,00	120	178	5709131046097	15	5



Step Drills designed for precise drilling in thin materials

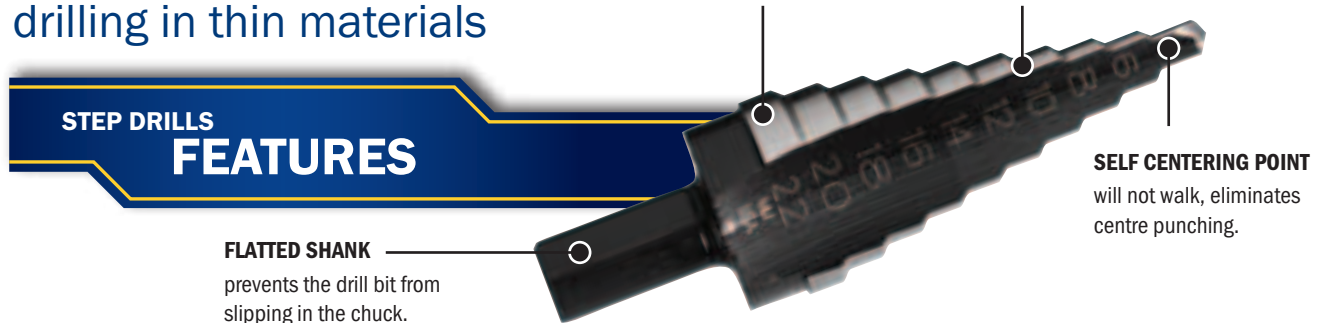

- **Single-fluted cutting edge** for greater control & rounder holes
- **Ideal for drilling holes in thin materials** such as mild steel, copper, brass, aluminum, plexiglass, wood and laminates
- **Unique flute design** ensures perfect round holes
- **Self-centring point** - will not walk, eliminates centre punching
- **Flatted shank** prevents the drill bit from slipping in the chuck
- **Made from industrial grade M7** high-speed steel

Step Drill Bits

Item No.	Description	EAN	Master Pack	Shelf Pack
10502850	1M 9 Hole sizes (4mm - 12mm), 1mm increments	0038548111018	5	1
10502851	2M 5 Hole sizes (4mm - 12mm), 2mm increments	0038548111025	5	1
10502852	3M 7 Hole sizes (6mm - 18mm), 2mm increments	0038548111032	5	1
10502853	4M 10 Hole sizes (4mm - 22mm), 2mm increments	0038548111049	5	1
10502854	5M 13 Hole sizes (5mm - 35mm), 2 - 3mm increments	0038548111056	5	1
10502855	PG29M10 Hole sizes 5 / 7,5 / 10 / 12,5 / 15,2 / 18,6 / 20,4 / 22,5 / 25,5 / 28,3mm	0038548111940	5	1
10502856	29MM 10 Hole sizes 5 / 7,5 / 10 / 13 / 16 / 19 / 21 / 23 / 26 / 29mm	0038548111957	5	1
10502857	ISO/PG13 Hole sizes 5 / 7,5 / 9,7 / 12,7 / 15,2 / 16,2 / 18,6 / 20,4 / 22,5 / 25,4 / 28,3 / 30,5 / 32,5mm	0038548111967	5	1
10502863	20M 6 Hole sizes (14 - 24mm)	0038548112206	5	1
10502864	21M 8 Hole sizes (20 - 34mm)	0038548112213	5	1

Wood Drilling



Blue Groove Power The longest lasting Flat Bit Ever!

BLUE GROOVE POWER FEATURES

1. Extreme Durability
Bi-metal cutting edges provide long life in tough applications.
2. Full Screw Tip
For ease of use and pull through.
3. Tapered Flute
For less binding and ease of use.

'Tri-Flute' Design
For faster chip ejection.
4. Compact Length
Designed to fit between studs in most common applications.

1/4" Quick Change Shank on Blue Groove Power 14-16mm.
3/8" Quick Change Shank on Blue Groove Power 18-32mm.

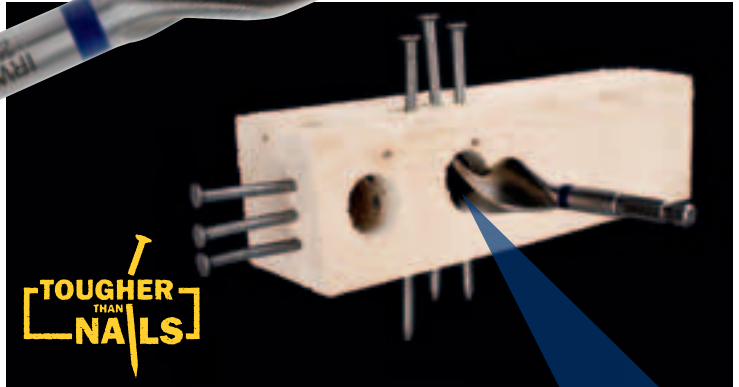
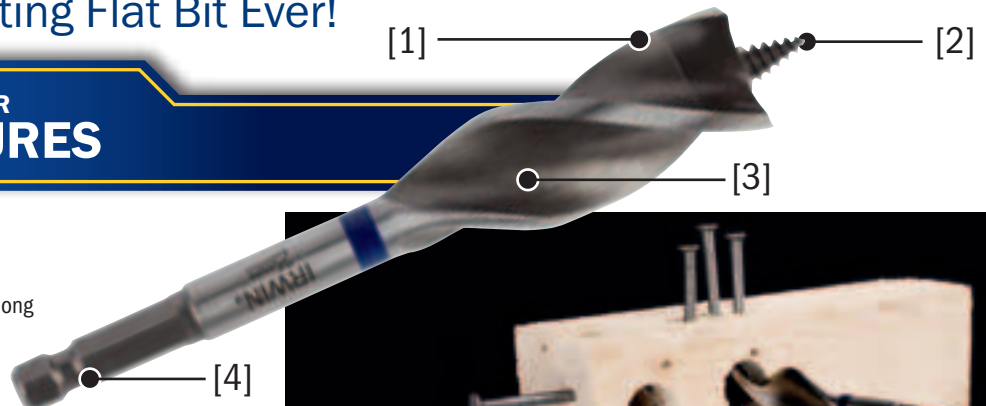

Nail Embedded Wood



*6 times faster versus basic flat bits



*50x longer life versus standard flat bits



Hex Shank

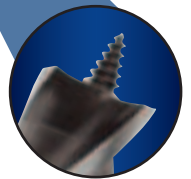

Blue Groove Power Wood Boring Bits

Item No.	Description / Diameter	EAN	Master Pack	Shelf Pack
10507712	BG Power 14mm	5706915077124	36	1
10507713	BG Power 16mm	5706915077131	36	1
10507714	BG Power 18mm	5706915077148	36	1
10507715	BG Power 20mm	5706915077155	36	1
10507716	BG Power 22mm	5706915077162	36	1
10507717	BG Power 25mm	5706915077179	36	1
10507718	BG Power 28mm	5706915077186	36	1
10507719	BG Power 32mm	5706915077193	36	1



Blue Groove Power Wood Boring Sets

Item No.	Description / Diameter	EAN	Master Pack	Shelf Pack
10507720	BG Power 3pcs Set: 14 / 16 / 18mm	5706915077209	36	1
10507764	BG Power 3pcs Set: 20 / 22 / 25mm	5706915077643	36	1



Blue Groove 6x The fastest Flat Bit Ever!

BLUE GROOVE 6X FEATURES

1. Cutting Spurs
For clean holes with minimal 'break out'
 2. Full Screw Tip
For ease of use and pull through
 3. Tapered Flute
For less binding and ease of use.

'Tri-Flute' Design
For faster chip ejection.
 4. Full Length Heat Treat
For extra durability
- Compact Length Designed to fit between studs in most common applications.
1/4" Quick Change Shank.

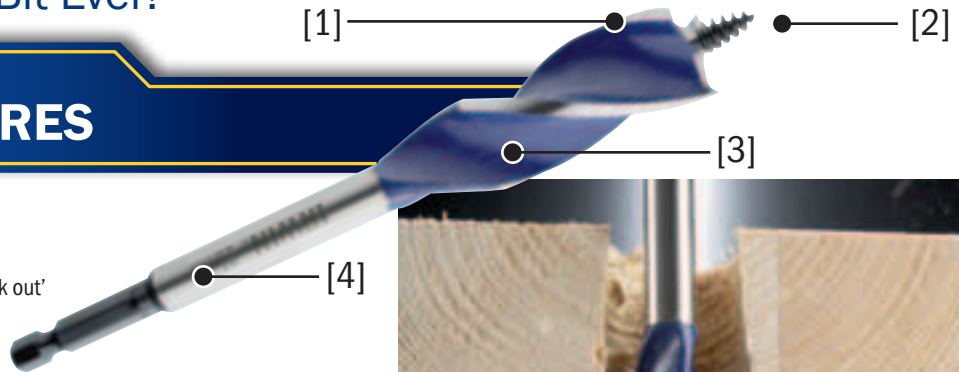

*6 times faster
versus basic
flat bits



Saves Battery
Life



Hex Shank



Wood

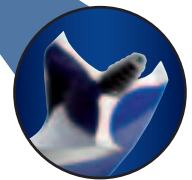
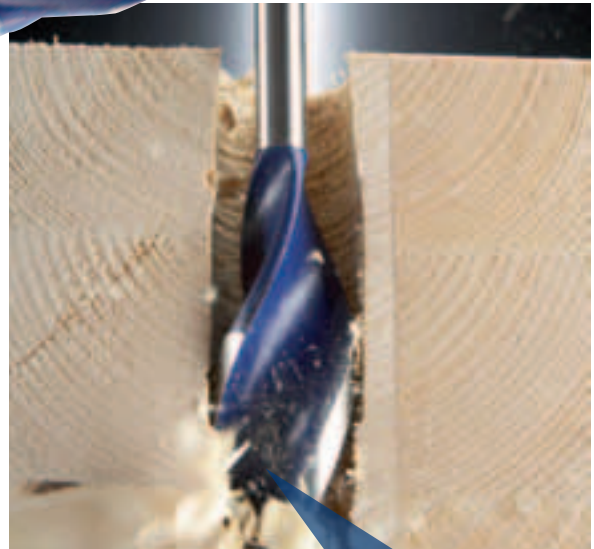

Blue Groove 6X Wood Boring Bits

Item No.	Description / Diameter	EAN	Master Pack	Shelf Pack
10507602	14 mm	5706915076028	36	6
10506620	16 mm	5706915066203	36	6
10506621	18 mm	5706915066210	36	6
10506622	20 mm	5706915066227	36	6
10506623	22 mm	5706915066234	36	6
10506624	25 mm	5706915066241	36	6
10506625	28 mm	5706915066258	36	6
10506626	32 mm	5706915066265	36	6



Blue Groove 6X Wood Boring Bit Sets

Item No.	Description / Diameter	EAN	Master Pack	Shelf Pack
10506627	3pcs Set: 20 / 22 / 25mm	5706915066272	6	1
10506628	6pcs Set: 16 / 18 / 20 / 22 / 25 / 32mm	5706915066289	6	1
10507604	6pcs Set: 14 / 16 / 18 / 20 / 22 / 25mm	5706915076042	6	1
10507593	8pcs mix Set: BG 4X (12/16/18/20/22mm); BG 6X (22/25/32mm)	5706915075939	6	1



Blue Groove 4x
4 times faster than standard Flat Bits

**BLUE GROOVE 4X
FEATURES**

1. Double Cutting Spurs scribe outside of the hole, reducing breakout.
2. Thicker Cutting Edge for longer drilling life.
3. BLUE-GROOVE Point & Cutting Edge for faster chip removal.
4. 10% larger shank - added durability.
5. 1/4" Quick Change Shank.

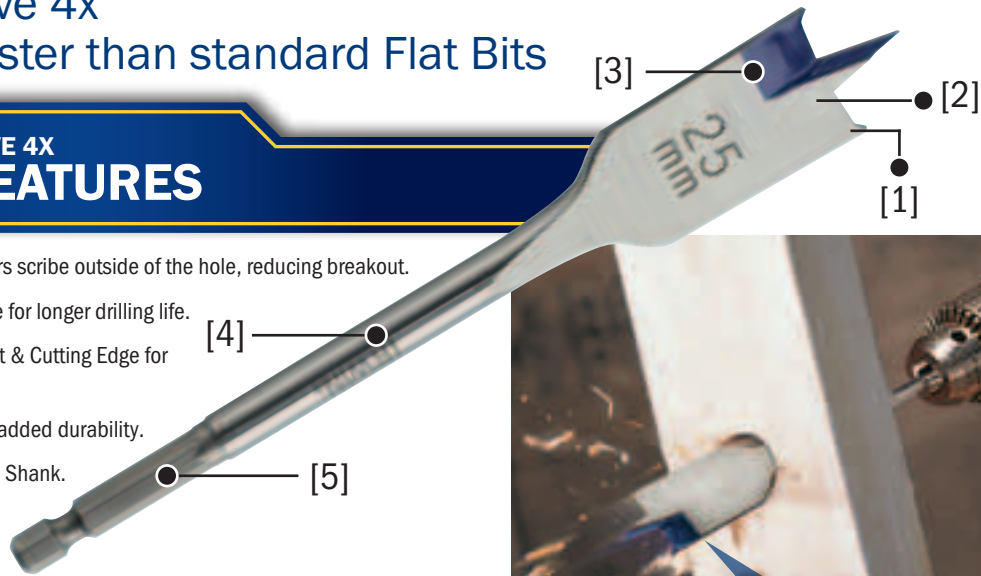

*4 times faster versus basic flat bits



Saves Battery Life



Hex Shank



Wood

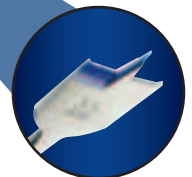

Blue Groove 4X Flat Bits - 152mm Length

Item No.	Description / Diameter	EAN	Master Pack	Shelf Pack
10502803	6mm	0024721013811	36	6
10502804	8mm	0024721013828	36	6
10502805	10mm	0024721013835	36	6
10502806	12mm	0024721013842	36	6
10502807	13mm	0024721013859	36	6
10502808	14mm	0024721013866	36	6
10502809	16mm	0024721013873	36	6
10502810	17mm	0024721889171	36	6
10502811	18mm	0024721013880	36	6
10502812	19mm	0024721013897	36	6
10502813	20mm	0024721013903	36	6
10502814	22mm	0024721013910	36	6
10502815	24mm	0024721013934	36	6
10502816	25mm	0024721013941	36	6
10502817	26mm	0024721013958	36	6
10502818	28mm	0024721013965	36	3
10502819	30mm	0024721013972	36	3
10502820	32mm	0024721013989	36	3
10502821	35mm	0024721014009	36	3
10502822	38mm	0024721014016	36	3
10502823	40mm	0024721889409	36	3





Blue Groove 4X Flat Bits - 400mm Length

- For extended reach
- Not for use with bit extensions or drill presses

Item No.	Description / Diameter	EAN	Master Pack	Shelf Pack
10502830	6mm	0024721886064	36	6
10502831	8mm	0024721886088	36	6
10502832	10mm	0024721013064	36	6
10502833	12mm	0024721014153	36	6
10502834	13mm	0024721014184	36	6
10502835	14mm	0024721013071	36	6
10502836	16mm	0024721014191	36	6
10502837	18mm	0024721014207	36	6
10502838	19mm	0024721013088	36	6
10502839	20mm	0024721014214	36	6
10502840	22mm	0024721014221	36	6
10502842	25mm	0024721014245	36	6
10502843	28mm	0024721014269	18	3
10502844	30mm	0024721014276	18	3
10502845	32mm	0024721014283	18	3
10502846	35mm	0024721014290	18	3



Blue Groove 4X Flat Bit Sets

Item No.	Description / Diameter	EAN	Master Pack	Shelf Pack
10502826	6pcs Set: 10 / 13 / 16 / 19 / 22 / 25mm - plastic wallet	0024721253149	48	6
10506629	8pcs Set: 12 / 16 / 18 / 20 / 22 / 25 / 28 / 32mm - hard pro set case	5706915066296	36	6
10507603	8pcs Set: 12 / 14 / 16 / 18 / 20 / 22 / 25 / 28mm - hard pro set case	5706915076035	36	6



Auger Bits

AUGER BIT FEATURES

1. Single Spur design for smoother hole finish
2. Coarse Screw Point for faster drilling into all types of wood
3. Fully hardened body from tip to shank for extra durability

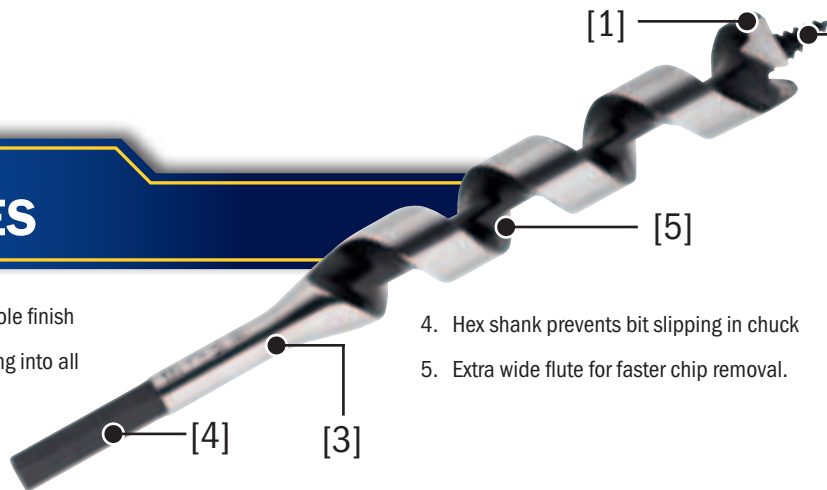

4. Hex shank prevents bit slipping in chuck
5. Extra wide flute for faster chip removal.



Auger Drill Bits

Item No.	Diameter mm	Working Length mm	Total Length mm	Shank Diameter mm	EAN	Master Pack	Shelf Pack
10502738	5	73	150	4,5	5709131135579	24	1
10502739	6	114	191	5,8	5709131133490	24	1
10502740	6	323	400	5,8	5709131133957	24	1
10502741	8	114	191	6,3	5709131133513	24	1
10502742	8	323	400	6,3	5709131133971	24	1
10502744	10	114	191	9,2	5709131133537	24	1
10502745	10	323	400	9,2	5709131133995	24	1
10502747	11	114	191	9,2	5709131133551	24	1
10502748	12	114	191	9,2	5709131133575	24	1
10502749	12	323	400	9,2	5709131134015	24	1
10502751	13	114	191	9,2	5709131133599	24	1
10502752	13	323	400	9,2	5709131134039	24	1
10502754	14	126	191	9,2	5709131133612	24	1
10502755	14	335	400	9,2	5709131134053	24	1
10502756	15	126	191	9,2	5709131133636	24	1
10502757	16	126	191	9,2	5709131133650	24	1
10502758	16	335	400	9,2	5709131134077	24	1
10502760	17	126	191	9,2	5709131133674	24	1
10502761	18	126	191	9,2	5709131133698	24	1
10502762	18	335	400	9,2	5709131134091	24	1
10502764	19	126	191	9,2	5709131133711	24	1
10502765	19	335	400	9,2	5709131134114	24	1
10502766	20	126	191	9,2	5709131133735	24	1
10502767	20	335	400	9,2	5709131134138	24	1
10502769	22	126	191	9,2	5709131133759	24	1
10502770	22	335	400	9,2	5709131134152	24	1
10502772	24	126	191	9,2	5709131133773	24	1
10502773	24	335	400	9,2	5709131134176	24	1
10502774	25	126	191	9,2	5709131133797	24	1
10502775	25	335	400	9,2	5709131134190	24	1
10502776	26	126	191	12,6	5709131133810	24	1
10502777	26	335	400	12,6	5709131134213	24	1
10502778	28	175	240	12,6	5709131133834	24	1
10502779	28	335	400	12,6	5709131134237	24	1
10502780	30	175	240	12,6	5709131133858	24	1
10502781	30	335	400	12,6	5709131134251	16	1
10502782	32	175	240	12,6	5709131133872	24	1
10502783	32	335	400	12,6	5709131134275	16	1
10502784	35	175	240	12,6	5709131133896	24	1
10502785	35	335	400	12,6	5709131134312	16	1
10502786	36	335	400	12,6	5709131134336	16	1
10502787	38	175	240	12,6	5709131133919	24	1
10502788	40	175	240	12,6	5709131133933	24	1

The Original
AUGER



Perfect for all types of wood
Creates perfect and straight holes



Auger Drill Bits Set

Item No.	Description / Diameter	EAN	Master Pack	Shelf Pack
10502791	10pcs Wallet: 6 / 8 / 10 / 12 / 14 / 16 / 20 / 22 / 28 / 30mm - standard length	5709131148838	3	1

Brad Point - precise drilling of clean holes

BRAD POINT FEATURES

1. Brad point tip guarantees accurate positioning for starting the hole.
2. Bit is precision-ground for use in furniture making, doweling, cabinetry and other woodworking applications where an exact hole size is required.
3. Spur cutting edges reduce splintering and ensure a smooth, clean hole.
4. Wide flutes provide a fast, continuous flow of chip ejection.

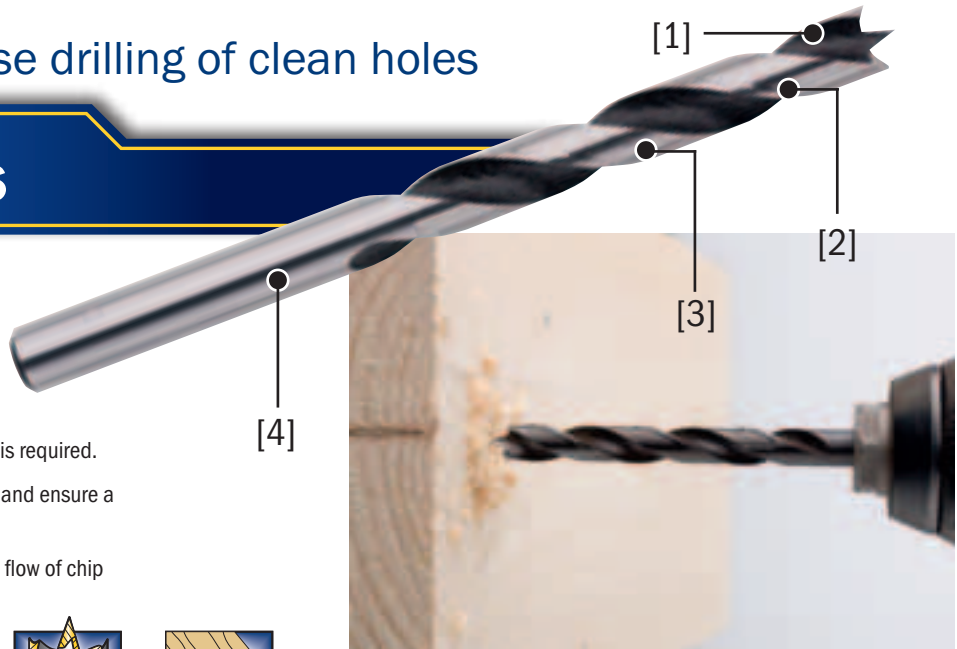

Perfect for all types of wood
Creates perfect and straight holes

Brad Point Drill Bits

Item No.	Diameter mm	Working Length mm	Total Length mm	EAN	Master Pack	Shelf Pack
10502792	3,0	37	67	5709131134534	200	10
10502793	4,0	52	88	5709131134558	200	10
10502794	5,0	59	95	5709131134572	200	10
10502795	6,0	67	103	5709131134596	200	10
10502796	8,0	78	119	5709131134619	200	10
10502797	10,0	87	136	5709131134633	200	10
10502798	12,0*	100	145	5709131134657	100	10
10502799	13,0*	104	149	5709131134671	100	10
10502800	16,0*	130	178	5709131134695	25	5



*Shank diameter 10mm

Item No.	Page	Item No.	Page	Item No.	Page	Item No.	Page	Item No.	Page	Item No.	Page	Item No.	Page
10502374	34	10502504	35	10502573	29	10502694	37	10502810	42	10503616	12	10507159	7
10502375	34	10502507	27	10502574	29	10502695	37	10502811	42	10503617	12	10507160	7
10502376	31	10502508	27	10502575	29	10502696	37	10502812	42	10503618	12	10507161	7
10502377	31	10502509	27	10502576	29	10502697	37	10502813	42	10503643	14	10507163	7
10502378	31	10502510	27	10502577	29	10502699	37	10502814	42	10503644	14	10507164	7
10502379	31	10502511	28	10502578	29	10502701	37	10502815	42	10503730	28	10507166	7
10502380	31	10502512	28	10502579	29	10502738	44	10502816	42	10503844	9	10507167	7
10502381	31	10502513	28	10502580	29	10502739	44	10502817	42	10503845	12	10507168	8
10502382	31	10502514	28	10502581	29	10502740	44	10502818	42	10503855	35	10507169	8
10502383	31	10502515	28	10502582	29	10502741	44	10502819	42	10503856	35	10507170	8
10502384	31	10502516	28	10502583	29	10502742	44	10502820	42	10503857	35	10507171	8
10502385	31	10502517	28	10502584	29	10502744	44	10502821	42	10503858	35	10507172	8
10502386	31	10502518	28	10502585	29	10502745	44	10502822	42	10503989	35	10507173	8
10502387	31	10502519	28	10502586	29	10502747	44	10502823	42	10503990	28	10507174	8
10502388	31	10502520	28	10502587	29	10502748	44	10502826	43	10503991	30	10507175	8
10502389	31	10502521	28	10502588	29	10502749	44	10502830	43	10503992	26	10507176	8
10502390	31	10502522	28	10502589	29	10502751	44	10502831	43	10503993	35	10507177	8
10502391	31	10502523	28	10502590	29	10502752	44	10502832	43	10504413	35	10507178	8
10502392	31	10502524	28	10502591	29	10502754	44	10502833	43	10504414	35	10507179	8
10502393	31	10502525	28	10502592	29	10502755	44	10502834	43	10504415	35	10507180	8
10502394	31	10502526	28	10502593	29	10502756	44	10502835	43	10504418	35	10507181	8
10502395	31	10502527	28	10502594	30	10502757	44	10502836	43	10504419	35	10507182	8
10502396	31	10502528	28	10502595	30	10502758	44	10502837	43	10504420	35	10507183	8
10502397	31	10502529	28	10502596	30	10502760	44	10502838	43	10506620	41	10507537	8
10502398	32	10502530	28	10502597	30	10502761	44	10502839	43	10506621	41	10507538	8
10502399	32	10502531	28	10502598	30	10502762	44	10502840	43	10506622	41	10507574	9
10502400	32	10502532	28	10502599	30	10502764	44	10502842	43	10506623	41	10507575	9
10502401	32	10502533	28	10502600	30	10502765	44	10502843	43	10506624	41	10507593	41
10502402	32	10502534	28	10502601	30	10502766	44	10502844	43	10506625	41	10507602	41
10502403	32	10502535	28	10502602	30	10502767	44	10502845	43	10506626	41	10507603	43
10502404	32	10502536	28	10502603	30	10502769	44	10502846	43	10506627	41	10507604	41
10502405	32	10502537	28	10502604	30	10502770	44	10502850	38	10506628	41	10507712	40
10502406	32	10502538	28	10502618	36	10502772	44	10502851	38	10506629	43	10507713	40
10502407	32	10502539	28	10502619	36	10502773	44	10502852	38	10507110	12	10507714	40
10502408	32	10502540	28	10502620	36	10502774	44	10502853	38	10507111	12	10507715	40
10502409	32	10502541	28	10502621	36	10502775	44	10502854	38	10507124	7	10507716	40
10502410	32	10502542	27	10502622	36	10502776	44	10502855	38	10507125	7	10507717	40
10502411	32	10502543	27	10502624	36	10502777	44	10502856	38	10507126	7	10507718	40
10502412	32	10502544	27	10502626	36	10502778	44	10502857	38	10507127	7	10507719	40
10502413	32	10502545	27	10502627	36	10502779	44	10502863	38	10507128	7	10507720	40
10502414	32	10502546	27	10502631	36	10502780	44	10502864	38	10507129	7	10507764	40
10502415	32	10502547	27	10502633	36	10502781	44	10503586	32	10507131	7	10507819	8
10502416	32	10502548	27	10502634	36	10502782	44	10503587	32	10507132	7	10507892	21
10502417	32	10502549	27	10502636	36	10502783	44	10503588	33	10507133	7	10507893	21
10502479	35	10502550	27	10502641	36	10502784	44	10503589	33	10507134	7	10507894	21
10502480	35	10502551	27	10502642	36	10502785	44	10503592	33	10507135	7	10507895	21
10502481	35	10502552	27	10502643	36	10502786	44	10503593	34	10507136	7	10507896	21
10502482	35	10502553	27	10502644	36	10502787	44	10503595	28	10507137	7	10507897	21
10502483	35	10502554	27	10502646	36	10502788	44	10503596	28	10507138	7	10507898	21
10502484	35	10502555	27	10502649	36	10502791	44	10503597	28	10507139	7	10507899	21
10502485	35	10502556	27	10502651	36	10502792	45	10503598	28	10507140	7	10507900	21
10502486	35	10502557	27	10502656	36	10502793	45	10503600	28	10507142	7	10507901	21
10502487	35	10502558	27	10502658	36	10502794	45	10503601	28	10507143	7	10507902	22
10502488	35	10502559	27	10502659	36	10502795	45	10503602	28	10507144	7	10507903	22
10502489	35	10502560	27	10502661	36	10502796	45	10503603	11	10507145	7	10507904	22
10502490	35	10502561	27	10502662	36	10502797	45	10503604	11	10507146	7	10507905	22
10502491	35	10502562	27	10502666	36	10502798	45	10503605	11	10507147	7	10507906	22
10502492	35	10502563	27	10502671	36	10502799	45	10503606	11	10507148	7	10507907	22
10502493	35	10502564	27	10502676	36	10502800	45	10503607	11	10507149	7	10507908	22
10502494	35	10502565	27	10502680	36	10502803	42	10503608	11	10507150	7	10507909	22
10502495	35	10502566	27	10502685	36	10502804	42	10503609	11	10507151	7	10507910	22
10502496	35	10502567	27	10502689	36	10502805	42	10503610	11	10507152	7	10507911	22
10502497	35	10502568	27	10502690	37	10502806	42	10503611	11	10507153	7	10507912	22
10502498	35	10502569	28	10502691	37	10502807	42	10503612	11	10507154	7		
10502499	35	10502570	28	10502692	37	10502808	42	10503613	11	10507156	7		
10502500	35	10502572	29	10502693	37	10502809	42	10503615	12	10507157	7		

Belgium

Newell Rubbermaid -
IRWIN Industrial Tool Company A/S
Drève Richelle 161/34, Building O
1410 Waterloo
Belgium
Tel: Netherlands +31 (0)202 06 16 38
Tel: Belgium +32 (0)22 00 83 55
Fax: +32 (0)23 52 38 08

Italy

Newell Rubbermaid -
IRWIN Industrial Tools
Viale Edoardo Jenner 55
20159 Milano - Italy
Tel: +39 02 - 66 80 67 61
Fax: +39 02 - 66 80 03 83

**Emerging Markets
(Middle East & Africa)**

A Newell Rubbermaid Company
Dubai Airport Free Zone
West Wing, Building 6W
Block-B, Office 640, PO Box - 54554
Dubai - United Arab Emirates
Tel: +971-4-2923444
Fax: +971-4-2923437

Eastern Europe

Newell Rubbermaid Poland II Sp. z o.o.
Manieczki, ul. Wybickiego 2
63-112 Brodnica - Poland
Tel: +48 (0)61 28 14 200
Fax: +48 (0)61 28 20 524

France

Newell Rubbermaid -
IRWIN Industrial Tools
122, avenue du Général Leclerc
92100 Boulogne Billancourt Cedex
France
Tel: +33 (0)1 46 84 42 70
Fax: +33 (0)1 46 84 42 92

Spain

Newell Rubbermaid -
IRWIN Industrial Tools
Calle Juana I de Castilla 24
28027 Madrid - Spain
Tel: +34 (0)91 354 4800
Fax: +34 (0)91 354 4849

Central Europe

Newell Rubbermaid -
IRWIN Industrial Tools GmbH
Schnackenburgallee 45
22525 Hamburg
Germany
Tel: +49 (0)69 380 789 435
Fax: +49 (0)69 380 789 542

UK

Newell Rubbermaid -
IRWIN Industrial Tools
Halifax Avenue, Fradley Park
Lichfield, Staffordshire WS13 8SS - England
Main Tel: +44 (0) 1543 44 70 01
Customer Service Tel: 0844 412 1190
Customer Service Fax: 0844 412 1184

Northern Europe

Newell Rubbermaid A/S
Stamholmen 157, 3 sal
2650 Hvidovre - Denmark
Tlf: +45 43 68 22 12
Fax: +45 43 68 22 13

Finland

Puh: +358 972 51 92 52
Faksi: +358 972 51 92 53

Sweden

Tel: +46 (0) 8-517 61 670
Fax: +46 (0) 8-517 61 671

Norway

Tel: +47 24 15 99 24
Fax: +47 24 15 99 25

